





7.1.1 Measures initiated by the institution for the promotion of gender equity.

1. Contents

1.	Initiatives IIST take to promotion of gender equity	6
2.	Event Name –International Woman’s Day Dated-9 th March 2024.....	21
	Event Report-International Woman’s Day	21
	International Women’s Day Approval.....	22
	A. International Women’s Day Notice	23
	B. International Women’s Day Pictures.....	24
	C. International Woman’s Day Attendance	25
3.	Event Name-“Rangoli Competition” Dated-19 th March,2024.....	29
	Event Report-“Rangoli Competition”.....	29
	D. Rangoli Competition Approval	30
	E. Rangoli Competition Notice	32
	F. Rangoli Competition Poster	33
	G. Rangoli Competition Glimpse	34
	H. Rangoli Competition Attendance	39
4.	Event Name-Drawing & Painting Competition Dated- 19 th March 2024.....	40
	Event Report-Drawing& Painting Competition.....	40
	I. Drawing & Painting Competition	41
	J. Drawing & Painting Competition Approval	42
	K. Drawing & Painting Competition Notice	43
	L. Drawing & Painting Competition Glimpse of the Event	43
	1. Drawing & Painting Competition Glimpse	45
	2. Drawing & Painting Competition Glimpse	46
	3. Drawing & Painting Competition Glimpse	47
	4. Drawing & Painting Competition Glimpse	48

For IIST/ IIPV IIMR
Chief Administrative Officer



Principal
Principal
Indore Institute of Science
and Technology, Indore
Saturday, December 21, 2024



Indore Institute of Science & Technology

Approved by AICTE, New Delhi, Affiliated to RGPV, Bhopal, Recognized by UGC under Section 2(f)
2023-2024

5.	Drawing & Painting Competition Glimpse	49
6.	Drawing & Painting Competition Glimpse	50
	M. Drawing & Painting Competition Attendance	51
5.	Event Name – Rangoli Competition Dated-9 th November2023	52
	Event Report-Rangoli Competition	52
	N. Rangoli Competition.....	53
	O. Rangoli Competition Approval.....	54
	P. Rangoli Competition Notice	55
	Q. Rangoli Competition Glimpse of the Events	56
	R. Rangoli Competition.....	57
	S. Rangoli Competition.....	58
	T. Rangoli Competition.....	59
	U. Rangoli Competition.....	60
	V. Rangoli Competition.....	61
	W. Rangoli Competition.....	62
6.	Event- National Girl Child Day	63
	National Girl Child Day- 25 Jan 2024	63
	X. National Girl Child Day- Approval & Notesheet- 21 May 2024.....	64
	Y. National Girl Child Day-Notice- 23 Jan 2024	65
	Z. Glimpse of National Girl Child Day	66
	AA. National Girl Child Day Attendance Sheet.....	67
7.	Event- Faag Utsav	68
	Faag Utsav- 22 March 2024.....	68
	BB. Faag Utsav- Approval & Note Sheet-19 march 2024	69
	CC. Faag Utsav- Notice- 18 March 2024	70
	DD. Glimpse & Social Link of Faag Utsav	71
	EE. Glimpse of Faag Utsav.....	72

IQAC

Principal
Principal

Indore Institute of Science
and Technology, Indore
Saturday, December 21, 2024

For IIST/ IIM/ IIMR
Chief Administrative Officer





FF. Event Details Of Faag Utsav.....	73
Faag Utsav Attendance Sheet Record-1.....	74
Faag Utsav Attendance Sheet Record-2.....	75
Faag Utsav Attendance Sheet Record-3.....	76
Faag Utsav Attendance Sheet Record-4.....	77
Faag Utsav Attendance Sheet Record-5.....	78
Faag Utsav Attendance Sheet Record-6.....	79
Faag Utsav Attendance Sheet Record-7.....	80
Faag Utsav Attendance Sheet Record-8.....	81
7. Indore Nodal Level Taekwondo (M/W) Team 2023-24	82
A. Indore Nodal Level Kabaddi (M/W) Team 2023-24 Dated- 02 Jan 2024	83
B. Indore Nodal Level Volleyball (M/W) Team 2023-24 Dated- 02 Jan 2024	84
C. Indore Nodal Level Basketball (M/W) Team 2023-24 Dated- 02 Jan 2024	85
D. Indore Nodal Level Football (M) Team 2023-24 Dated- 08 Jan 2024	86
E. Indore Nodal Level Cricket (M) Team 2023-24	87
F. List of Participated Players in RGPV	88
8. Permission to organize IIST Annual Sports Meet Approval Letter Dated- 5 March 2024	89
G. IIST Annual Sports Notice Dated- 5 March 2024	90
H. Remuneration Bill for Referees/Umpire Dated- 18 March 2024.....	91
I. Annual Sports Note Sheet Dated- 14 March 2024.....	92
J. Duty List of Faculties/Staff.....	93
K. Result List of the Winners & Runners Team Attached	94
9. Event- Annual Sport Meet Dated- 16 to 17 March 2024	96
L. IIST Annual Sports Meet Cricket (Boys) Fixture	100
M. IIST Annual Sports Meet Basketball (Boys) Fixture.....	101
N. IIST Annual Sports Meet Volleyball (Boys) Fixture.....	102

IQAC

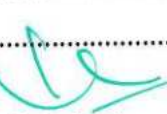
Principal

Principal

Indore Institute of Science

Saturday, December 21, 2024

For IIST/ IIP/ IIMR
Chief Administrative Officer





Indore Institute of Science & Technology

Approved by AICTE, New Delhi, Affiliated to RGPV, Bhopal, Recognized by UGC under Section 2(f)
2023-2024

O.	IIST Annual Sports Meet Basketball (Girls) Fixture	103
P.	IIST Annual Sports Meet Volleyball (Girls) Fixture.....	104
Q.	IIST Annual Sports Meet Cricket (Boys Team).....	105
R.	IIST Annual Sports Meet Basketball(Boys & Girls Team).....	106
S.	IIST Annual Sports Meet Volleyball Score Sheet	107
T.	IIST Annual Sports Meet Table Tennis Score Sheet	108
U.	IIST Annual Sports Meet Scoresheet	109
V.	IIST Annual Sports Meet Pickleball Score Sheet	110
10.	Report on National Sports Day Celebration Dated- 29 Aug 2023	116
W.	National Sports Day Celebration Approval Letter Dated- 16 Aug 2023	117
X.	Sports Notice Dated- 17 Sep 2023	119
Y.	National Sports Day Celebration Attendance Sheet Record.....	120
Z.	Glimpse of National Sports Day Celebration	121
11.	Intra Hostel Premier League 6th to 12th June 2024 Event Report Dated- 12 June 2024	123
AA.	Intra Hostel Premier League Sports Notice Dated- 2 nd June 2024	124
BB.	Intra Hostel Premier League Approval Letter Dated- 1 st June 2024.....	125
CC.	Intra Hostel Premier League Attendance Sheet Record- 1st Year Students...	127
DD.	Intra Hostel Premier League Attendance Sheet Record- 2 nd Year Students...	128
EE.	Intra Hostel Premier League Attendance Sheet Record- 3 rd Year Students ...	129
FF.	Intra Hostel Premier League Attendance Sheet Record- 4 th Year MBA, M. Pharma Students.....	130
GG.	Intra Hostel Premier League Attendance Sheet Record – Hostel 1st Year Students.....	131
HH.	Intra Hostel Premier League Attendance Sheet Record- 1Ralamandal 2nd Year Students.....	133

 For IIST/ IIP/ IIMR
 Chief Administrative Officer



 Principal
 Indore Institute of Science and Technology, Indore

Saturday, December 21, 2024



Approved by AICTE, New Delhi, Affiliated to RGPV, Bhopal, Recognized by UGC under Section 2(f)
2023-2024

II.	Intra Hostel Premier League Attendance Sheet Record- Hostel 2nd Year Students.....	134
JJ.	Event- Inter College Tournament Report Dated- 18 March 2024	136
KK.	Items Requires for Annual Sports Meet Note Sheet Dated- 14 March 2024.....	138
12.	Intra Hostel Premier League Report Dated- 12 June 2024.....	139
LL.	Intra Hostel Premier League Sport Notice Dated- 2 nd June 2024.....	140
MM.	Intra Hostel Premier League Approval Letter Dated- 1 st June 2024.....	141
NN.	Hostel Premier League 2024.....	142
OO.	Intra Hostel Premier League 1 st Year Student Attendance	143
PP.	Intra Hostel Premier League 2 nd Year Student Attendance	144
QQ.	Intra Hostel Premier League 3 rd Year Student Attendance	145
RR.	Intra Hostel Premier League 4 th Year Student MBA, M. Pharma Attendance	146
SS.	Hostel 1 st Year Student Details.....	147
TT.	Hostel 2 nd Year Student Attendance	149

For IIST/ IIP/ IIMR
Chief Administrative Officer



Principal
Principal
Indore Institute of Science
and Technology, Indore
Saturday, December 21, 2024



7.1.1 Measures initiated by the institution for the promotion of gender equity.

1. Initiatives IIST take to promotion of gender equity:

IIST has a clear policy that gender is not the basis for imparting education and dealing with the faculty.

1.Safety and Security:

IIST campus has over 200 CCTV cameras, Security guards and Gunmen that provide 24/7 security throughout the campus; Institute has established a secure entry and exit system, where only authorised students and employees may enter. The girls' hostel has high walls, barbed wires fences and grills on the windows/galleries.

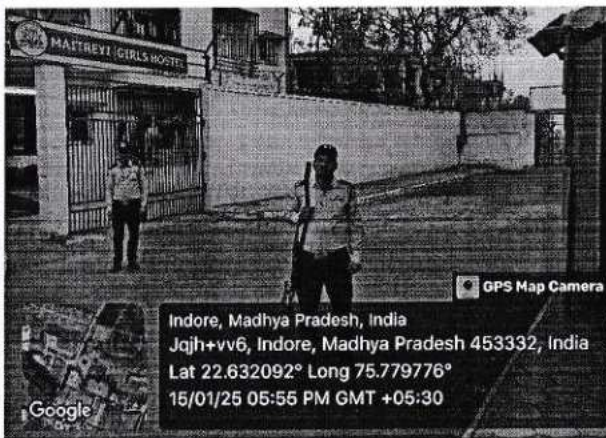
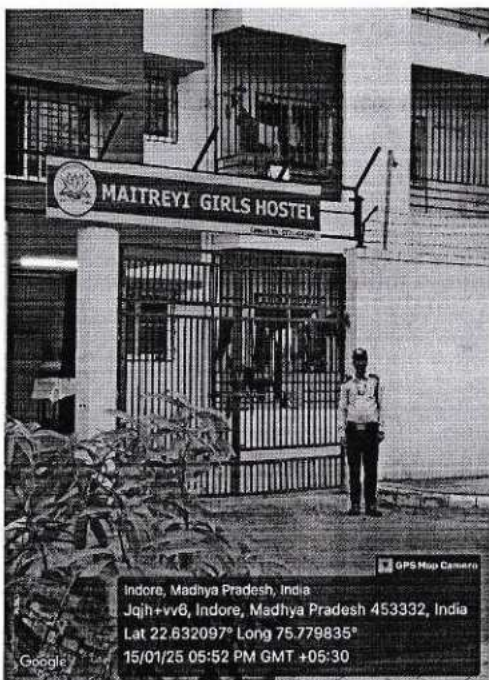

Guards, Gunmen, Gate, Grills, High Boundry Walls, Barbed Wires in the girls hostel

For IIST/ IIP/ IIMR
[Signature]
Chief Administrative Officer

[Signature]
IQAC



[Signature]
Principal
Principal

Indore Institute of Science
& Technology, Indore
Saturday, December 21, 2024



IIST
Indore Institute of
Science & Technology

Indore Institute of Science & Technology

Approved by AICTE, New Delhi, Affiliated to RGPV, Bhopal, Recognized by UGC under Section 2(f)
2023-2024

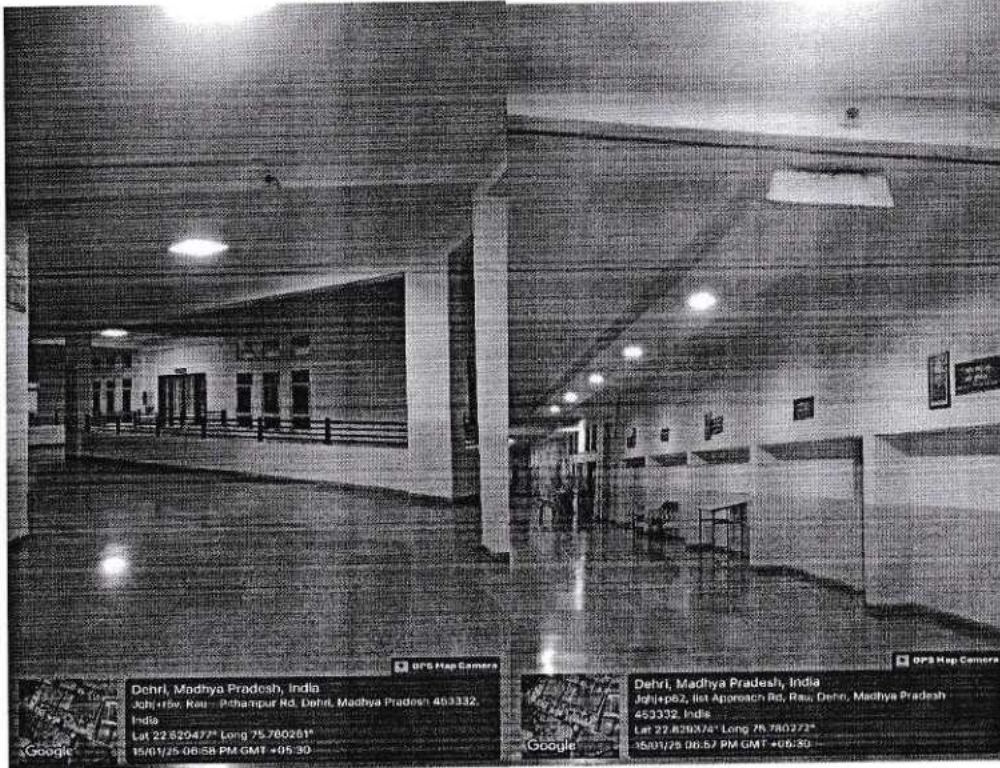

CCTV Cameras in the campus



IQAC

[Signature]
For IIST/ IIP/ IIMR
Chief Administrative Officer



[Signature]
Principal
Principal
Indore Institute of Science
and Technology, Indore
Saturday, December 21, 2024



IIST
Indore Institute of
Science & Technology

**Indore Institute of
Science & Technology**

Approved by AICTE, New Delhi, Affiliated to RGPV, Bhopal, Recognized by UGC under Section 2(f)
2023-2024

CCTV Camera in the buses

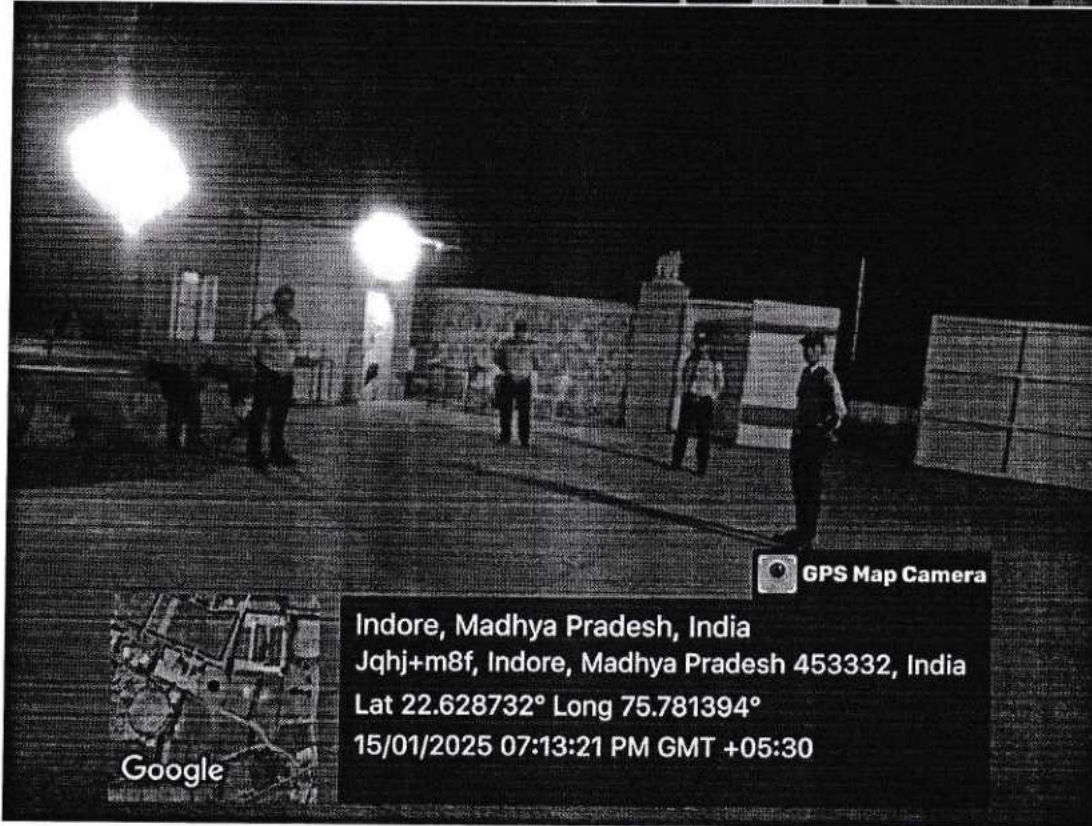
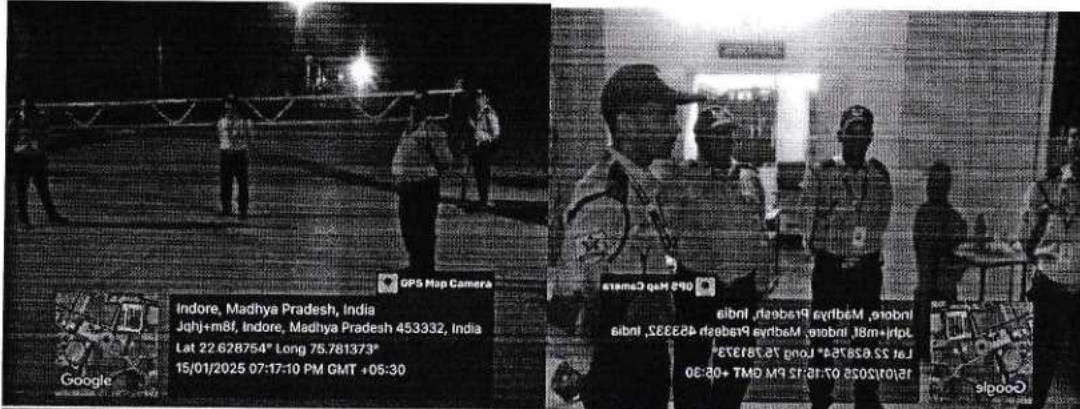

Secured Gate with Barriers and Security Guards

[Signature]
FOR IIST/STP/ IIMR
Chief Administrative Officer



Principal
Principal
Indore Institute of Science
and Technology, Indore

Saturday, December 21, 2024

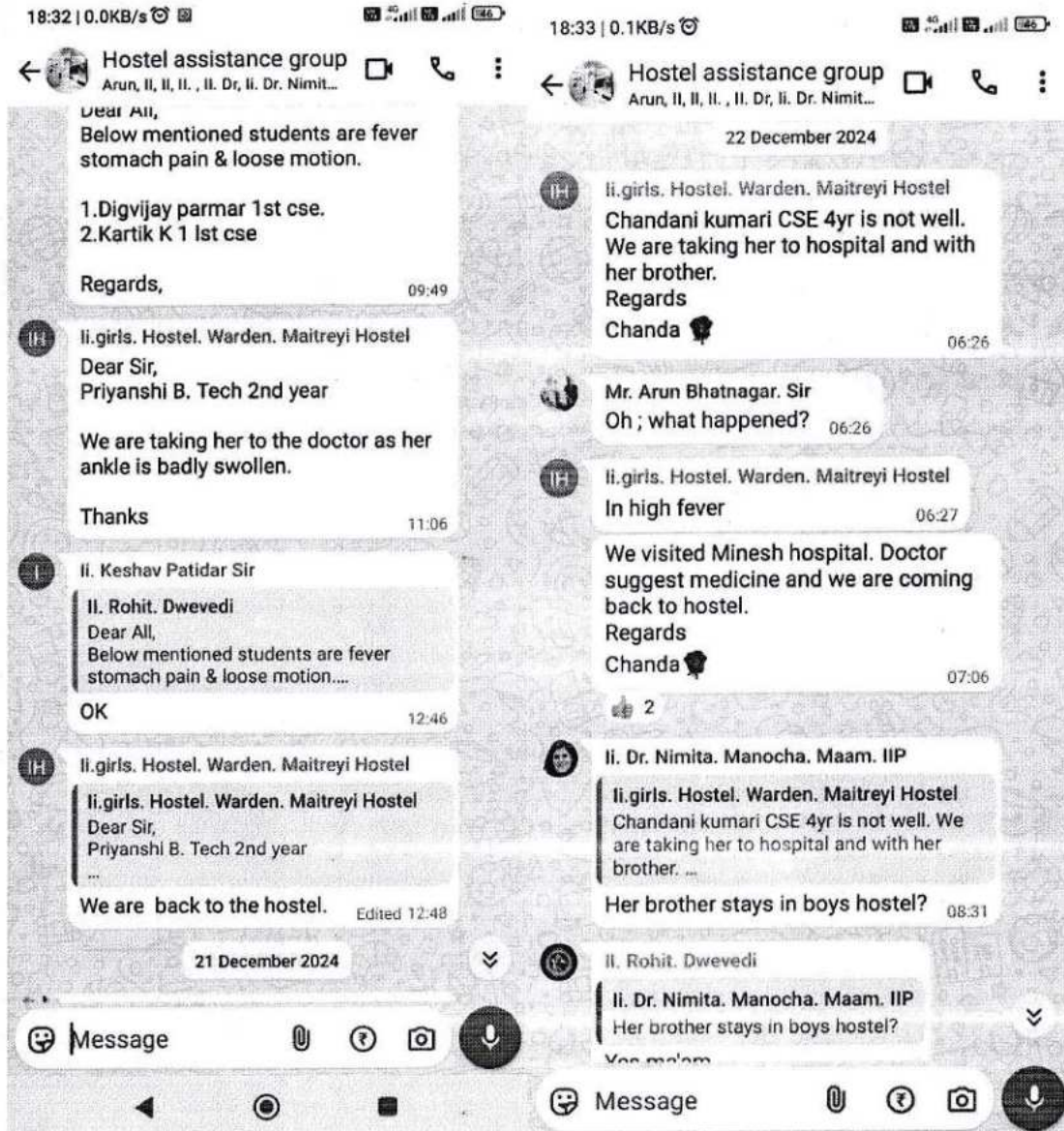

2. Hostel Assistance WhatsApp Group is specially made to give the first information report for any issues of the hostel. The issues are addressed by the senior authorities like Warden Principal, CAO and Group Advisor and is solved.

For IIST/ IIP/ IIMR
Chief Administrative Officer



Principal
Indore Institute of Science
and Technology, Indore
Saturday, December 21, 2024



Indore Institute of Science & Technology

Approved by AICTE, New Delhi, Affiliated to RGPV, Bhopal, Recognized by UGC under Section 2(f) 2023-2024

3. Counselling Services:

IIST has set up dedicated counselling centres with trained counsellors to address gender-specific issues. Offer regular counselling sessions and workshops on mental health and well-being.



Indore Institute of Science & Technology

IIST/June-23/06

Academic Year 2023-24

Date: 09/06/2023

Students Counsellor Committee

This is to inform all of you that the Institute has constituted 'Students Counsellor Committee' for the academic year 2023-24 as mentioned below:

Sr. No.	Name	Designation	Email ID	Contact No.
1.	Dr. Parimeeta Chanchani	Chairman	parimeeta.chanchani@indoreinstitute.com	9981161212
2.	Dr. Veena Dadwani	Co-Chairman	veena.dadwani@indoreinstitute.com	9826299199
3.	Mr. Rajesh Tiwari	Member	tiwari@indoreinstitute.com	9926439911
4.	Ms. Vimmy Katyal	Member	vimmy.katyal@indoreinstitute.com	7649898220
5.	Ms. Rupali Tiwari	Member	rupali.tiwari@indoreinstitute.com	9893874577
6.	Mr. Pradeep Baniya	Member	pradeep.baniya@indoreinstitute.com	9893195529
7.	Mr. Devendra Singh Mandloi	Member	devendra.mandloi@indoreinstitute.com	8770935398
8.	Mr. Ishanya Joshi	Member	ishanya.joshi@indoreinstitute.com	9131442046
9.	Mr. Shantanu Roy	Member	shantanu.roy@indoreinstitute.com	8224075000
10.	Mr. Pankaj Malviya	Member	pankaj.malviya@indoreinstitute.com	9826674572

(Dr. Keshav Patidar)
Principal, IIST, Indore

- CC to:
1. All Students,
 2. All Faculty and Staff,
 3. Dean/HoDs,
 4. Registrar Office,
 5. Admin Dept.,
 6. DG Office,

For IIST/ IIP/ IIMR
Chief Administrative Officer

IQAC



Principal
Principal
Indore Institute of Science
and Technology, Indore
Saturday, December 21, 2024



4. Gender Sensitization Workshops:

Organize workshops, seminars, and guest lectures on gender sensitization. Include topics like gender equality, rights, and responsibilities in the curriculum. This is done from the first year itself with the Abhigyata Parv Induction program. The CAO in his session sensitised the students about gender equity and rights.

5 Anti-Sexual Harassment Cell:

IIST has establish an Internal Complaints Committee (ICC) to address cases of sexual harassment. Conduct regular training sessions for staff and students on the prevention of sexual harassment.



Internal Complaint Committee
(Anti-Sexual harassment)

The Internal Complaint Committee (Anti-Sexual harassment) has been constituted at IIST. The Internal Compliant Committee for prevention of sexual harassment of women at workplace, as per AICTE Regulation, 2016 to deal with the sexual harassment complaints of women at workplace. The following are the members of the internal complaint committee as mention below:

Sr. No.	Name	Designation	Email ID	Contact No.
1.	Dr. Richa Gupta (Vice Principal-2 & HOD-AIML)	Presiding Officer	richa.gupta@indoreinstitute.com	9755647074
2.	Dr. Namrata Kaushal (Dean & Course Director-1 First Year)	Member	namrata.kaushal@indoreinstitute.com	9826075667
3.	Dr. Parimeeta Chanchani (Associate Prof. - ESH)	Member	parimeeta.chanchani@indoreinstitute.com	9981161212
4.	Mr. Abhay Sahasrabudde (CAO-2)	Member	abhay.sahasrabudde@indoreinstitute.com	7471120010
5.	Mr. Gajendra Dubey (Registrar)	Member	gd@indoreinstitute.com	9165360604
6.	Mr. Aakshay Chilhate (Student)	Member	akshay.chilhatecs2021@indoreinstitute.com	9826756948
7.	Ms. Yukta Kokreja (Student)	Member	yukta.kokreja2021@indoreinstitute.com	8817902600
8.	Ms. Ruchita Jawle (Student)	Member	ruchita.jawlece2020@indoreint	6263532634
9.	Ms. Deepika Choudhary (NGO-AMPS)	Member	deepadubey652@gmail.com	9826802082

(Dr. Keshav Patidar)
Principal, IIST, Indore

CC to:

1. All Students,
2. All Faculty and Staff,
3. Dean/HoDs,
4. Registrar Office,
5. Admin Dept.,
6. DG Office,

For IIST/ IIP/ IIMR
Chief Administrative Officer

IQAC



Principal

Principal

Indore Institute of Science

and Technology, Indore

Saturday, December 21, 2024



Indore Institute of Science & Technology

Approved by AICTE, New Delhi, Affiliated to RGPV, Bhopal, Recognized by UGC under Section 2(f)
2023-2024

6. Women's Grievance Redressal Cell:

IIST created a Women's GR Cell to plan for the welfare of female. It Organize programs on women's health, legal rights, and career development.



Indore Institute of Science & Technology

IIST/June-23/03

Academic Year 2023-24

Date: 09/06/2023

The Women's' Grievance Redressal Cell

The Women's Grievance Redressal Cell for settling issues apart from sexual harassment at workplace: The following are the members of the Women's Grievance Redressal Cell:

Sr. No.	Name	Designation	Email ID	Contact No.
1.	Dr. Namrata Kaushal	Chairman	namrata.kaushal@indoreinstitute.com	9826075667
2.	Dr. Parimeeta Chanchani	Co-Chairman	parimeeta.chanchani@indoreinstitute.com	9981161212
3.	Dr. Richa Gupta	Member	richa.gupta@indoreinstitute.com	9755647074
4.	Dr. Margi Patel	Member	margi.patel@indoreinstitute.com	9713362915
5.	Dr. Neena Thacker	Member	neena.thacker@indoreinstitute.com	9826914202

The Cell is required to work in the direction of providing help to any female complaining of discrimination, either gender discrimination or otherwise, any kind of abuse, loneliness, peer pressure, groupism, home sickness, insecurity and/or inferiority complex in terms of physical appearance, hostel issues, harassment from room-mates, adjusting and adopting to the new environment, etc.

(Dr. Keshav Patidar)
Principal, IIST, Indore

CC to:

1. All Faculty and Staff,
2. Dean/HoDs,
3. Registrar Office,
4. Admin Dept.,
5. DG Office,
6. Office record.

For IIST/ IIN/ IIMR

Chief Administrative Officer



Principal

Principal

Indore Institute of Science
and Technology, Indore

Saturday, December 21, 2024



7. Equal Opportunity to the employees and students:

IIST follows a policy of equal opportunities Set up an Equal Opportunity Cell to ensure non-discriminatory practices in admissions, recruitment, and promotions. Monitor and report on gender equity initiatives.

8. Support and Facilities for Female Students:

Provide scholarships, financial aid, and mentorship programs for female students. Ensure equal access to resources and opportunities

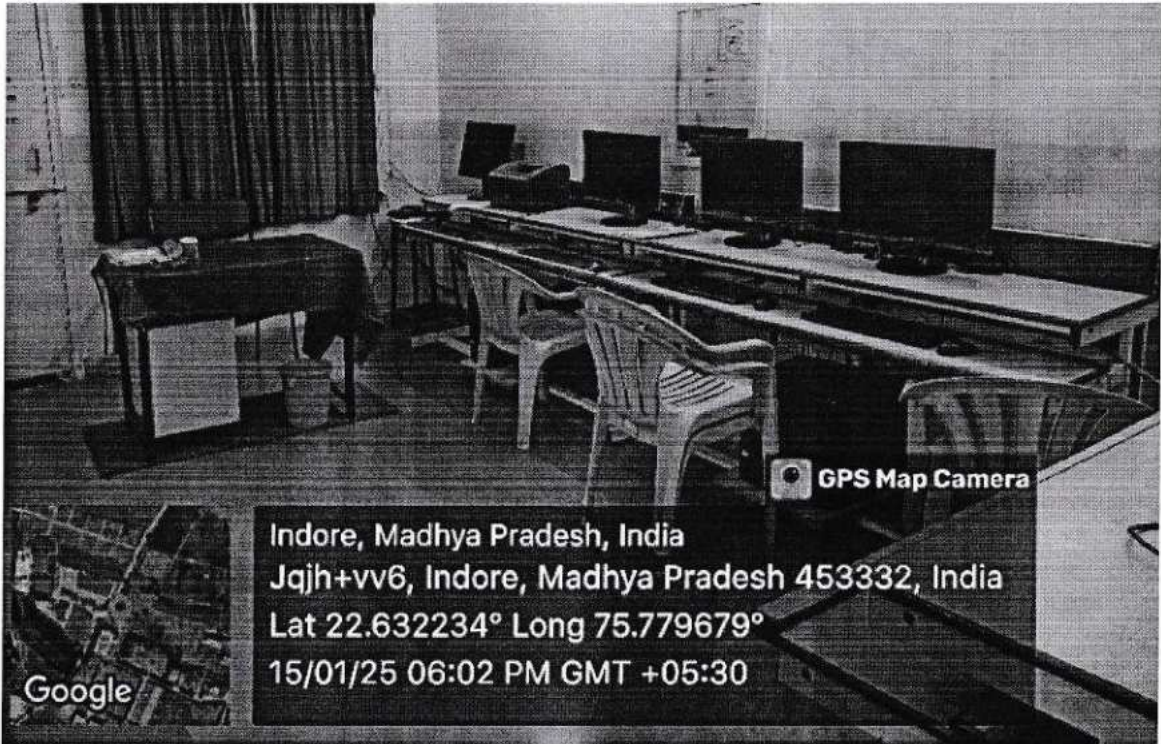

Dedicate Computer Lab in the Girls Hostel

For IIST/ IIP/ IIMR
Chief Administrative Officer



IOAC

Principal

Principal
Indore Institute of Science
Saturday, December 21, 2024



IIST
Indore Institute of
Science & Technology

**Indore Institute of
Science & Technology**

Approved by AICTE, New Delhi, Affiliated to RGPV, Bhopal, Recognized by UGC under Section 2(f)
2023-2024

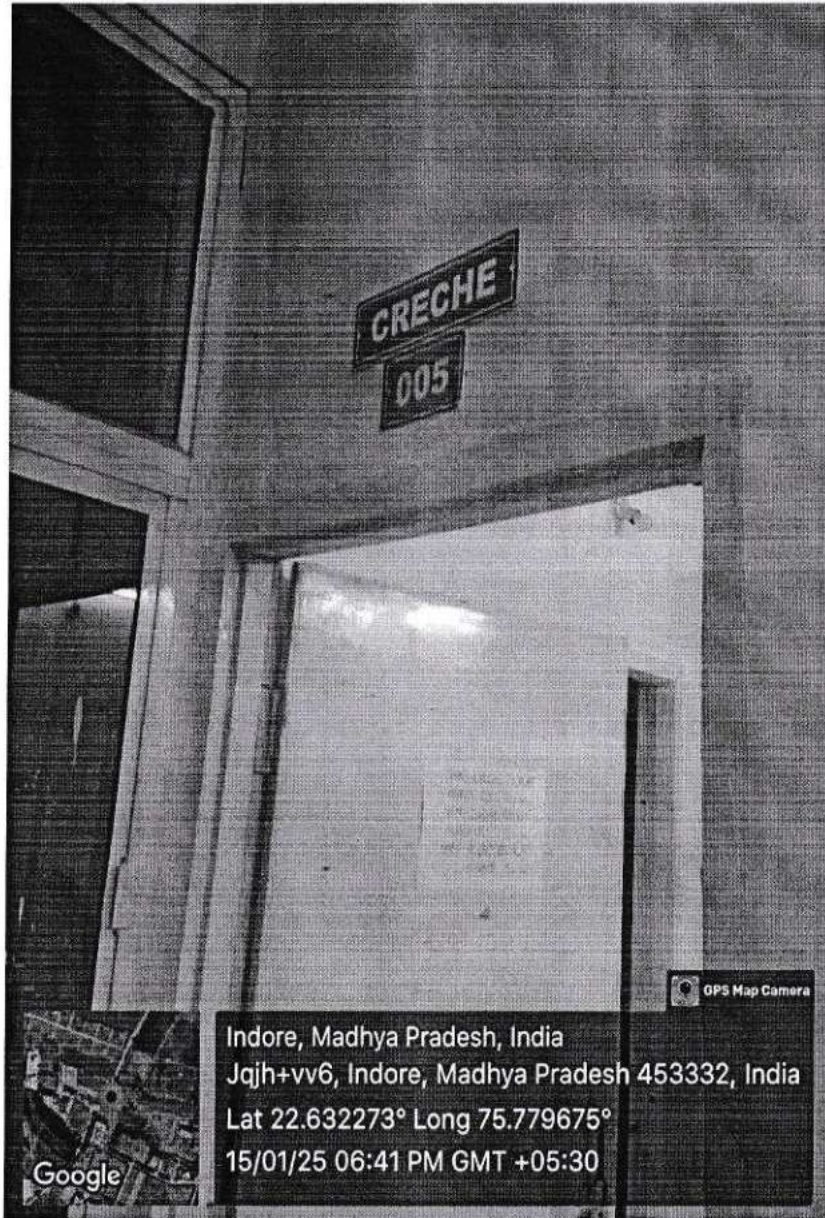

Day Care Centre & Feeding Room.

[Signature]
For IIST/ IIP/ IIMR
Chief Administrative Officer



[Signature]
IQAC

[Signature]
Principal

[Signature]
Principal
Indore Institute of Science
Technology, Indore
Saturday, December 21, 2024



IIST
Indore Institute of
Science & Technology

Indore Institute of Science & Technology

Approved by AICTE, New Delhi, Affiliated to RGPV, Bhopal, Recognized by UGC under Section 2(f)
2023-2024



Girls Common Room (GCR)

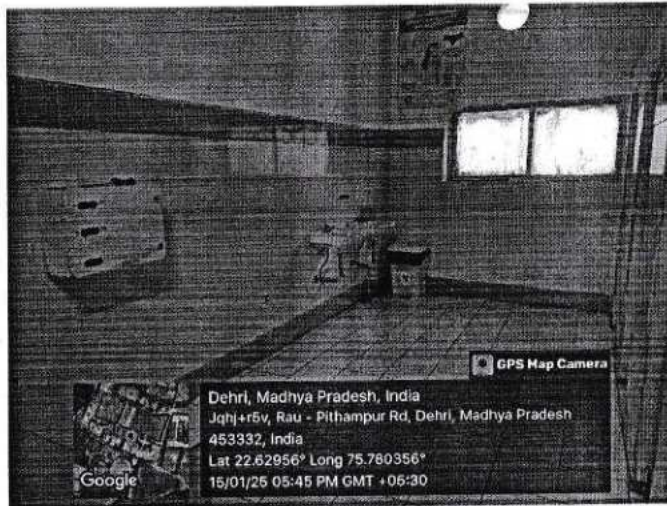

Sanitary Vending Machine in the Ladies toilet.

[Signature]
For IIST/ IIR/ IIMR
Chief Administrative Officer



[Signature]

Principal
Indore Institute of Science
& Technology, Indore
Saturday, December 21, 2024

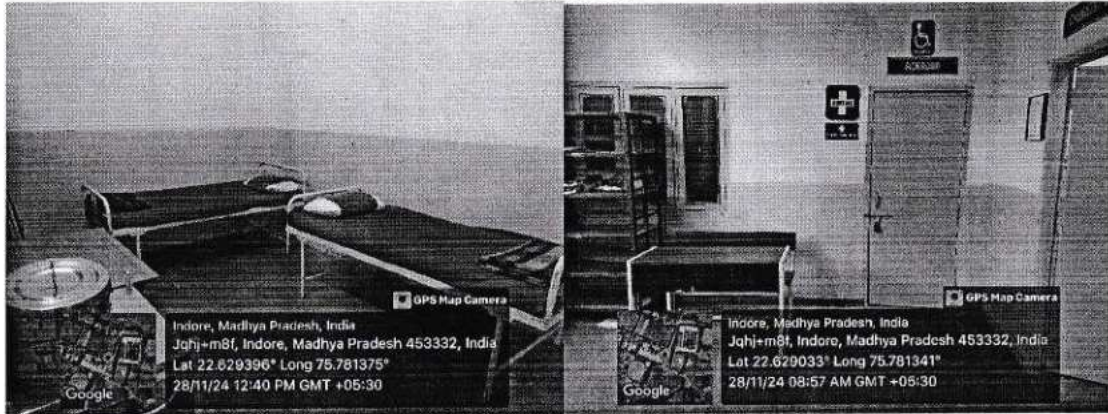

Sick room facility in the Institute.

216ac398f4b444fca7d6aaed	
Rewards	50,000 per annum
Eligibility	Giri students admitted to 1st year of diploma/degree programme
Application Last Date	31st October 2024
Official Website	www.nsp.gov.in

Pragati Scholarship 2024-25 - Eligibility Criteria

To apply for the Pragati Scholarship, female candidates must be studying in an AICTE-approved college/institution. The details of the AICTE Pragati Scholarship eligibility criteria are given below.

- Applicants must be admitted to the 1st year or 2nd year (through lateral entry only) of the technical diploma/degree programme of an AICTE-approved college/institute in the current academic year through the centralised admission process of the State/Central Government.
- Two females per family are eligible to apply for the scholarship.
- The annual family income of the applicant must not exceed ₹8,00,000 during the preceding financial year. (Note:- In case the applicant is married, the income of parents/in-laws is considered, whichever is higher)

Pragati Scholarship 2024-25 - Key Documents

There are a few necessary documents that the applicants must keep with them while filling the Pragati Scholarship application form. The candidates must upload scanned copies of the following documents to complete their application process.

- Class 10 marksheet
- Class 12 marksheet
- Aadhaar card
- Applicant's passport-size photo
- Signature of the candidate
- Annual family income certificate of the preceding financial year in the prescribed format by the Tehsildar or above competent Authority
- Admission letter issued by the Centralized Admission Authority to first-year Degree/Diploma programs for the current academic year
- Receipt of paid tuition fee for the current academic year
- Aadhaar-linked bank passbook showing the applicant's name, account

IQAC

Principal

For IIST/ IIP/ IIMR
Chief Administrative Officer



Principal
Indore Institute of Science
& Technology Indore
Saturday, December 21, 2024



Indore Institute of Science & Technology

Approved by AICTE, New Delhi, Affiliated to RGPV, Bhopal, Recognized by UGC under Section 2(f) 2023-2024

IIST follows a policy of equal opportunities to ensure non-discriminatory practices in admissions, recruitment, and promotions. Men and women have equal access to all opportunities, fostering a fair and inclusive environment. In the Student Activity Council, equal representation is provided to the faculty and students. <https://iist.indoreinstitute.com/wp-content/uploads/2023/12/Annexure-8-Student-Activity-Committee-SAC-AY-2023-24.pdf>

Sample Page of the document,



Indore Institute of Science & Technology

Affiliated to - RGPV (Bhopal) & Approved by - AICTE (New Delhi)

IIST/Aug.-23/01

Academic Year 2023-24

Date: 02nd Aug, 2023

Student Activity Committee (SAC)

Student activity cell has been constituted at Indore Institute of Science and Technology. The institute has well organized structure of 19 student activity clubs. The clubs include Co-Curricular, Extra Curricular and Technical activity clubs. These students driven clubs aim to the holistic development of students along with curriculum. To support the students, faculty coordinators have been assigned to each activity club. The detailed list of clubs, their student coordinators and faculty coordinators are mentioned in attached list.

1. **Society for Contemporary Affairs (Lexicon Club):** To organizes various literary activities like debates, quiz, and panel discussion and paper presentations on contemporary/ national/ international issues to inculcate the habit of reading and bring about awareness for contemporary affairs.

Sr. No.	Department	Faculty Coordinator	Contact No
1	IIST(CDC)	Ms. Shweta Bahrani	9827374874
2	IIST(ESH)	Ms. Rupali Tiwari	9893875477
3	IIST(CDC)	Ms. Jaya Singh	8979811003

Club	President	Vice- President	Secretary
Lexicon	Nitya Kasera	Nav Raj Rana	Kuldeep Pawar

For IIST/ IIP/ IIMR
Chief Administrative Officer

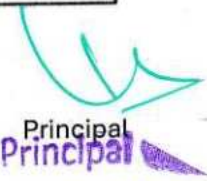

Principal
of Science
Indore

Saturday, December 21, 2024



Indore Institute of Science & Technology

Approved by AICTE, New Delhi, Affiliated to RGPV, Bhopal, Recognized by UGC under Section 2(f)
- 2023-2024

12. Inclusive and Balanced Leadership:

IIST promotes gender diversity in leadership positions within the institution; in the leadership position of the institute, 05 out of 9 departments have female heads and in-charges. Of the total faculty strength of 130, 47 members are females. IIST encourage female staff and students to take on leadership roles. In the student clubs and societies, __coordinators are females. IIST has Balanced representation of both genders are well represented in committees, sports teams, technical activities, and cultural events

List of HOD's

S.No	Name of the Head	Gender
1	Dr. Nirai Kumar Soni	Male
2	Dr. Namrata Kaushal	Female
3	Dr. Ankit Saxena	Male
4	Dr. Richa Gupta	Female
5	Dr. Satish Panchela	Male
6	Dr. Margi Patel	Female
7	Mr. Ankit Jain	Male
8	Dr. Shewta Agrawal	Female
9	Dr. Ritu Gupta	Female

Admission Data 2023-24

S.No	Boys (In %)	Girls (In %)	Year
1	76.01	23.98	2023-24
2	74.4	25.59	2022-23
3	77.44	22.57	2021-22
4	80.18	19.82	2020-21
5	80.23	19.76	1019-20

For IIST/ IIP/ IIMR
Chief Administrative Officer



Principal
Principal
Indore Institute of Science
Indore
Saturday, December 21, 2024



Indore Institute of Science & Technology

Approved by AICTE, New Delhi, Affiliated to RGPV, Bhopal, Recognized by UGC under Section 2(f)
2023-2024

13. Regular Monitoring and Evaluation:

IIST has establish a system for regular monitoring and evaluation of gender equity initiatives. Use feedback and data to continuously improve and adapt programs and policies. These measures and methodologies aim to create a safe, inclusive, and equitable environment for all students and staff.

14. Creating awareness and participation of females:

Various cultural and sports events are organised, where participation of females is encouraged. Special sports leagues and fixtures for girls are organised. International Womens' day was observed with great fanfare. Women leaders from academia and industry were appreciated and honoured. A special Womens' Car Rally was organised.

For IIST/ IIP/ IIMR
Chief Administrative Officer



Page 20 of 150

Principal
Principal
Indore Institute of Science
Technology, Indore
Saturday, December 21, 2024



Indore Institute of Science & Technology

Approved by AICTE, New Delhi, Affiliated to RGPV, Bhopal, Recognized by UGC under Section 2(f)
2023-2024

International Women's Day | Approval

IIST
Indore Institute of Science and Technology
Approved by AICTE, New Delhi & Affiliated to RGPV, Bhopal

Note Sheet & Approval

International Women's Day (8th March), on 9th March 2024

Date: 05/03/2024

On International Women's Day (8th March), Department of ESH is organizing an expert lecture on 9th March 2024. Dr. Nisha Joshi, International Yoga Guru & Spiritual Speaker will be the session expert. For the same following arrangements are required:



Details of requirements:

1. Auditorium 2 with all the arrangements.
2. Bouquet- 3 nos.
3. Book- 1 No.
4. Planters - 2 Nos
5. Memento for the speaker - 1 No.
6. Remuneration for invited speaker (Rs. 2000/-)
7. Vehicle for Pick & Drop of Guests
8. Tea & Refreshment for 7 persons

Coordinators

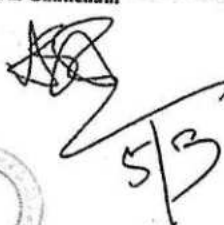
Dr. Namrata Kaushal 

Dr. Parimeeta Chanchani 

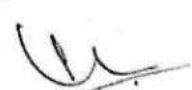
Principal
Indore Institute of Science
and Technology, Indore

For IIST/ IIP/ IIMR
Chief Administrative Officer



Principal
Indore Institute of Science

Saturday, December 21, 2024



IIST
Indore Institute of
Science & Technology

Indore Institute of Science & Technology

Approved by AICTE, New Delhi, Affiliated to RGPV, Bhopal, Recognized by UGC under Section 2(f)
2023-2024

A. International Women's Day | Notice

 **INDORE INSTITUTE OF SCIENCE & TECHNOLOGY**
Approved by: AICTE, New Delhi & Affiliated to RGPV, Bhopal

NOTICE

Date: 7/03/24

This is to inform all that we are celebrating International Women's Day on 9th March 2024. All the girls' students and female faculty & staff members will attend the program All are required to assemble at Auditorium II at 2:00 PM.



 Principal
 Indore Institute of Science
 and Technology, Indore



 For IIST/ IIP/ IIMR
 Chief Administrative Officer





 Principal
 Indore Institute of Science
 Technology, Indore
 Saturday, December 21, 2024





B. International Women's Day | Pictures

IIST
Indore Institute of Science and Technology
Approved by AICTE, New Delhi & Affiliated to RGPV, Bhopal

Glimpse of Event -

Coordinators 

Principal 
Indore Institute of Science
and Technology, Indore

For IIST/ IIP/ IIMR
Chief Administrative Officer



Principal
Indore Institute of Science
and Technology, Indore

Saturday, December 21, 2024



C. International Woman's Day | Attendance

Int. Women Day celebration
9/03/24

INDORE INSTITUTE OF SCIENCE & TECHNOLOGY
NAME OF ACTIVITY: ... International Women's Day - 8 March

S.No	Name	Department	Signature
1	Pooja Chandra	ESH	[Signature]
2	Asli Pandey	ESH	[Signature]
3	Saanand Khandekar	CSE	[Signature]
4	Namrata Khandekar	ESH	[Signature]
5	Veena Thakur	ESH	[Signature]
6	Nyrestha Shrestha	CSE	[Signature]
7	Akansa Agrawal	ESH	[Signature]
8	Pooja Mandloi	Admin	[Signature]
9	Shikha Marwade	CSE	[Signature]
10	Archana Sasawat	ESH	[Signature]
11	Jaya Singh	CRC	[Signature]
12	Mandakini Soni	CSE	[Signature]
13	Veena Dadvani	CSE	[Signature]
14	Deepika Kulkarni	CSE	[Signature]
15	Shachi Kadam	ESH	[Signature]
16	Shikha Mandloi	Admin	[Signature]
17	Vinay Khandelwal	CRC	[Signature]
18	Preeti Dixit	ESH	[Signature]
19	Pooja Shukla	CSE	[Signature]
20	Subhali Agrawal	CSE	[Signature]
21	Shikha Gupta	ESH	[Signature]
22	Rubali Tiwari	ESH	[Signature]
23	Shikha Shrivastava	CSE	[Signature]
24	Pragyaena Joshi	CSE	[Signature]
25	Arushi Gupta	CSE	[Signature]
26	Muskan Chougale	ESH	[Signature]
27	Suman Palecha	ESH	[Signature]
28	Lakshmi	CSE	[Signature]
29	Deepika	Admin	[Signature]
30	Shamika Sharma	CSE	[Signature]
31	Nayab Saha	CSE	[Signature]
32	Anshika Thakur	CSE	[Signature]
33	Mitali Tiwari	CSE	[Signature]
34	Shreya Bhatnagar	CSE	[Signature]
35	Rati Gupta	CSE	[Signature]
36	Ample Subhija	EC	[Signature]
37	Pooja Lashkari	CSE	[Signature]
38	Reena	CSE	[Signature]
39	Sushma Ingle	IIP	[Signature]
40	Mika Rethekar	CSE	[Signature]
41	Asha Mishra	JMR	[Signature]
42	Pragati Dehadra	CSE	[Signature]
43	Asinohali Singh	ESH	[Signature]



[Signature]
For IIST/IIP/IIMK
Chief Administrative Officer

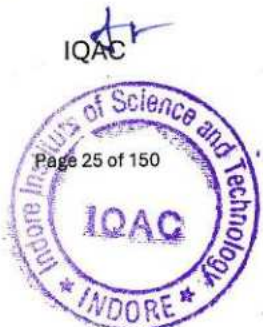

[Signature]
Principal
Principal
Indore Institute of Science
Saturday, December 21, 2024



INDORE INSTITUTE OF SCIENCE & TECHNOLOGY
NAME OF ACTIVITY:

S.No	Name	Department	Signature
1	Alasadhya Kassay	AIML	[Signature]
2	Aayushi Kravipat	JOT	[Signature]
3	Anshika	AIML	[Signature]
4	Sachin Malviya	AIML	[Signature]
5	Jishu	CS	[Signature]
6	Apaksha Sulasudra	JOT	[Signature]
7	KOMAL SITALI	CS	[Signature]
8	Gurjan Sisodiya	JOT	[Signature]
9	Abhinav Malakar	AIML	[Signature]
10			
11	Diksha Akran	AIML	[Signature]
12	Charan Patel	AIML	[Signature]
13	Kunjika Kunte	CS	[Signature]
14	Tushita Jain	JOT	[Signature]
15	Komal Sabte	CS	[Signature]
16	Fatema	AIML	[Signature]
17	Diksha Akran	AIML	[Signature]
18	Mohi	CS	[Signature]
19	Pankaj	CS	[Signature]
20	Muskan Jorhi	CS	[Signature]
21	Abhinav Malakar	AIML	[Signature]
22	Mahim Mali	CS	[Signature]
23	Harshita Dhayal	JOT	[Signature]
24	Manasti Garg	AIML	[Signature]
25	Neha	CS	[Signature]
26	Kavya Khandwal	AIML	[Signature]
27	Neha Sharma	CS	[Signature]
28	Mansi Nahar	AIML	[Signature]
29	Isak	CS	[Signature]
30	Sharvani	AIML	[Signature]
31	Charan Patel	AIML	[Signature]
32	Payal Vishwakarma	CS	[Signature]
33	Palak Sharma	AIML	[Signature]
34	Pooja Mishra	CS	[Signature]
35	Palak Dronawat	JOT	[Signature]
36	Pranshi Chandawat	CS	[Signature]
37	Raja Mishra	AIML	[Signature]
38	Madarvi Gangrade	AIML	[Signature]
39	Princy Yadav	CS	[Signature]
40	Sahil Jain	AIML	[Signature]
41	Anshika Punj	AIML	[Signature]
42	Kadisha Ankolnerkar	CS	[Signature]
43	Mahi Rajgurunandan	JOT	[Signature]

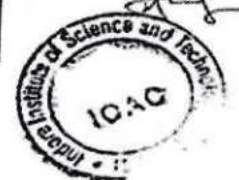
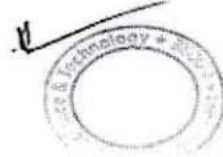

IQAC

Principal

Principal

Indore Institute of Science

Indore, India
Saturday, December 21, 2024

For IIST/ IIP/ IIMR
Chief Administrative Officer





INDORE INSTITUTE OF SCIENCE & TECHNOLOGY
NAME OF ACTIVITY:

S.No	Name	Department	Signature
1	Kruti Ka Kachole	AIML	[Signature]
2	Sandhya Maheshwari	AIML	[Signature]
3	Riya Visoni	CS	[Signature]
4	Sakshi Pasdeani	CSE	[Signature]
5	Sambhavi Nodha	CSE	[Signature]
6	Harshita Soni	AIML	[Signature]
7	Sakshi Choudhary	CSE	[Signature]
8	Sarna Parnel	CSE	[Signature]
9	Shikha Somani	CSE	[Signature]
10	Muskan Sharma	JOT	[Signature]
11	Shamam	CSE	[Signature]
12	Shikha Somani	CSE	[Signature]
13	Muskan Adhu	AIML	[Signature]
14	Shreya Lalit	CSE	[Signature]
15	Shreya Lalit	CSE	[Signature]
16	Shreya Lalit	JOT	[Signature]
17	Shubham	CSE	[Signature]
18	Shubham	CSE	[Signature]
19	Tanisha Jaiswal	CSE	[Signature]
20	Tanya Nigam	CSE	[Signature]
21	Preeti Tanwar	JOT	[Signature]
22	Tanishka Bhadani	CSE	[Signature]
23	Nandini Singh	AIML	[Signature]
24	TANIYA NAGAR	CSE	[Signature]
25	Tanika Mandh	CSE	[Signature]
26	Kanak Rawat	AIML	[Signature]
27	Vishnu	CSE	[Signature]
28	Zahra Hussain	CSE	[Signature]
29	Piha Khan	CSE	[Signature]
30	Himanshi Upadhyay	AIML	[Signature]
31	Kirti Pawar	CSE	[Signature]
32	Nishita	AIML	[Signature]
33	Veetika	CSE	[Signature]
34	Vanshika Chavhan	JOT	[Signature]
35	Anika Garg	CS	[Signature]
36	Sheetal	CSE	[Signature]
37	KANAK PANDE	CSE	[Signature]
38	Mansi Nahar	AIML	[Signature]
39			
40			
41			
42	Yashika Bana	JOT	[Signature]
43			



FOR IIST/IIP/IIMR
[Signature]
Chief Administrative Officer



[Handwritten signature]

Principal
Principal
Indore Institute of Science
Indore

Saturday, December 21, 2024



44			
45	Uma Kholars	CSC	
46	Richa Kholars	AME	
47	Smriti Gupta	CSE	
48	Chiranjeev	SST	
49	Alakshya	Admission	
50	Pratik	DSM	
51	Ms. Nitesh Rawal	Student section	Nitesh Rawal
52	Ms. Vibhuti	Admin.	Vibhuti
54	Haleema Munsoni	Admin.	Haleema
57	Shruti Jalambone Phanna		Shruti
58	Amrisha Pattak		Amrisha
59	Smritika Kishore		Smritika
60	Ashita Bijawa		Ashita

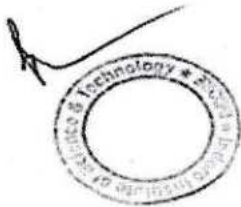

[Signature]
IQAC

[Signature]
Principal

[Signature]
For IIST/ IIP/ IIMR
Chief Administrative Officer



[Signature]
Principal
Indore Institute of Science and Technology
Saturday, December 21, 2024

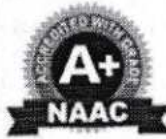

Indore Institute of Science & Technology

Approved by AICTE, New Delhi, Affiliated to RGPV, Bhopal, Recognized by UGC under Section 2(f)
2023-2024

3. Event Name-“Rangoli Competition” | Dated-19th March,2024

Event Report-“Rangoli Competition”

Indore Institute of Science and Technology
Approved by AICTE, New Delhi & Affiliated to RGPV, Bhopal

Event Report

Academic Year: 2023-24 Sessions: Jan-June 2024

Name of Event: “Rangoli Competition”

Theme of the Event: “No theme”

Date of Event: 19/03/2024

Organizing Dept.: Art Club, IIST

No. of Students Participated: 12

Event Coordinator: Poonam Bagora
Shanu Sharma
Sneha Nagar



Student Coordinators: 1. Mansi Awasthi 8269160153
2. Pratham Tomar 7415374235

Summary

On 19th March 2024, an event was organized with the participation of 12 students at IIST, IIP and IIMR in Dazzle 2024. A rangoli competition without a specific theme allows participants to freely express their creativity and cultural heritage through the traditional art form of rangoli. Rangoli, originating from India, involves creating intricate designs using colored powders, rice flour, flower petals, or other materials. In this type of competition, participants have the freedom to design their rangolis based on their imagination, personal style, and traditional techniques. The absence of a theme encourages a diverse range of designs, each reflecting the individuality and cultural background of the artist.

Participants are typically given a designated space to create their rangolis within a specified time frame. Judging criteria often include creativity, originality, technical skill, symmetry, use of colors, and overall aesthetic appeal. Judges, often consisting of artists, cultural experts, or community members, evaluate the rangolis and award prizes to the winners.

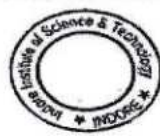
Rangoli competitions without a theme provide participants with an opportunity to celebrate their cultural heritage, showcase their artistic talents, and engage with their community. Such events promote cultural exchange, appreciation for traditional art forms, and the spirit of creativity and unity.

 

For IIST/IIP/ IIMR
Chief Administrative Officer



Principal
Principal
Indore Institute of Science
& Technology, Indore
Saturday, December 21, 2024





Indore Institute of Science and Technology

Approved by AICTE, New Delhi & Affiliated to RGPV, Bhopal

Event Highlights:

The event began with an inaugural session by Director General, Shri Arun S Bhatnagar. They addressed our faculty members, staff along with youth of today our students.

Conclusion:

The event witnessed the active participation of 12 students who demonstrated their dedication to Art. They expressed their thoughts and art by Rangolis. Students had expressed their creativity, culture, and colors in the most vibrant way.

FB link –
<https://www.facebook.com/100064495487764/posts/nfbid0KcYCEr4SaDTgFNZi9SMPrUFe5vkdz564w9YvzekLuoHujMIdacXRMDYXJviSW4ofEi/>

Instagram Link :
<https://www.instagram.com/reel/C4nnpikxeT2/?igsh=NTe4MTlwNjQ2YQ==>

The Winners are-

1. Ankush Sardiya
2. Kanishka Didwaniya
3. Prachi Mavkar

Event Coordinators

Poonam Bagora 

Shanu Sharma 

Sneha Nagar 





Principal
Principal
Indore Institute of Science
and Technology, Indore

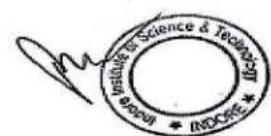



D. Rangoli Competition |Approval

 For IIST/ IIP/ IIMR
 Chief Administrative Officer



 Principal
 Indore Institute of Science
 and Technology, Indore
 Saturday, December 21, 2024



Indore Institute of Science and Technology
Approved by AICTE, New Delhi & Affiliated to RGPV, Bhopal

Approval Letter

Date: 14/03/2024

Respected Sir,

We are planning to organize an event on "Rangoli competition" on 19th march 2024 at IIST, IIP, IIMR for all the students ,faculty and staff members of IIST Group of Institutes .

Kindly approve the same for conducting the activity.

COORDINATORS
POONAM BAGORA
SHANU SHARMA
SNEHA NAGAR

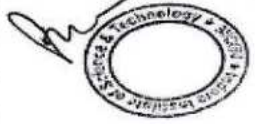

PRINCIPAL
Principal
Indore Institute of Science
and Technology, Indore



For IIST/ IIP/ IIMR
Chief Administrative Officer



Principal
Principal
Indore Institute of Science
& Technology, Indore
Saturday, December 21, 2024





E. Rangoli Competition| Notice



 **Indore Institute of Science and Technology**
Approved by AICTE, New Delhi & Affiliated to RGPV, Bhopal

DATE: 14/03/2024

NOTICE

This is to inform all the students, faculty and staff members of IIST Group of institutes that "Rangoli competition" On 19th march 2024 at IIST. IIP and IIMR in Dazzle 2024.

HOD / COORDINATOR



PRINCIPAL
 Principal
 Indore Institute of Science
 and Technology, Indore

For IIST/ IIP/ IIMR

Chief Administrative Officer



Principal
Principal
Indore Institute of Science
and Technology, Indore

Saturday, December 21, 2024



IIST
Indore Institute of
Science & Technology

**Indore Institute of
Science & Technology**

Approved by AICTE, New Delhi, Affiliated to RGPV, Bhopal, Recognized by UGC under Section 2(f)
2023-2024

F. Rangoli Competition| Poster

Glimpse of the Event

Poster Circulated among Students

Dazzle
2k24
Annual Function

15 March 2024
FILMOTSAV
Mr. Ansh Jain - 92371 98827 | Mr. Anurag Duggal - 90831 30561

18 March 2024
INTER COLLEGE SPORTS (9:00 am - 4:00 pm)
Dr. Subhash Mishra/Sonoo - 9983062853

18-19 March 2024
HACKATHON (24 hrs)
Dr. Manoj Patel - 9713162915

18-20 March 2024
**RANGOLI, PHOTOGRAPHY, FILM MAKING,
DRAWING & PAINTING**
Dr. Neetu Agrawal - 72250 06488 | Dr. Poojai Doshi - 88002 74286
Ms. Poojani Bagaria - 88260 06648 | Dr. Ansh Doshi - 96172 40882

20 March 2024
ROBO RACE (9:30 am - 12:00 noon)
Ms. Anshu Mishra - 99916 34242

IDEATHON (10:00 am - 11:00 am)
Mr. Nishant Vatswani - 99772 15522

MODEL PARLIAMENT (10:00 am - 04:00 pm)
Dr. Vansh Desai - 98262 99979

21 March 2024
CULTURAL & FASHION SHOW (9:30 am - 01:00 pm)
Dr. Neha Sonu - 87510 93118
(Lunch Break 1:00 pm - 02:00 pm)

HOLLYWOOD MUSIC EVENING (3:00 pm - 05:00 pm)
Ms. Neelam Dubey

22 March 2024
QUIZ (10:00 am - 11:30 pm)
Dr. Karanesh Chavhan - 92811 61212 | Dr. Anshu Sonu - 98262 24755

POETRY (11:30 am - 03:00 pm)
Dr. Neetu Mishra - 98262 14302

FAAG UTSAV (HOLI) (2:30 pm - 04:00 pm)
Mr. Rajul Thapar - 90918 75477

Opp. IIM[Indore], Rau-Pithampur Road, Rau, Indore (MP)
Toll Free: 1800 103 3059 | www.indoreinstitute.com
822 107 1000/2500/3500 / 822 403 1000/2500

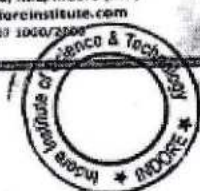

[Signature]
For IIST/ IIP/ IIMR
Chief Administrative Officer



Principal
Principal
Indore Institute of Science
Indore
Saturday, December 21, 2024



IIST
Indore Institute of
Science & Technology

**Indore Institute of
Science & Technology**

Approved by AICTE, New Delhi, Affiliated to RGPV, Bhopal, Recognized by UGC under Section 2(f)
2023-2024

G. Rangoli Competition | Glimpse



[Handwritten Signature]
For IIST/ IIP/ IIMR
Chief Administrative Officer



[Handwritten Signature]
Principal
Principal
Indore Institute of Science
and Technology, Indore
Saturday, December 21, 2024



IIST
Indore Institute of
Science & Technology

**Indore Institute of
Science & Technology**

Approved by AICTE, New Delhi, Affiliated to RGPV, Bhopal, Recognized by UGC under Section 2(f)
2023-2024



Indore Institute of Science and Technology
Approved by AICTE, New Delhi & Affiliated to RGPV, Bhopal

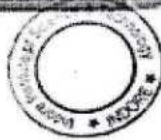
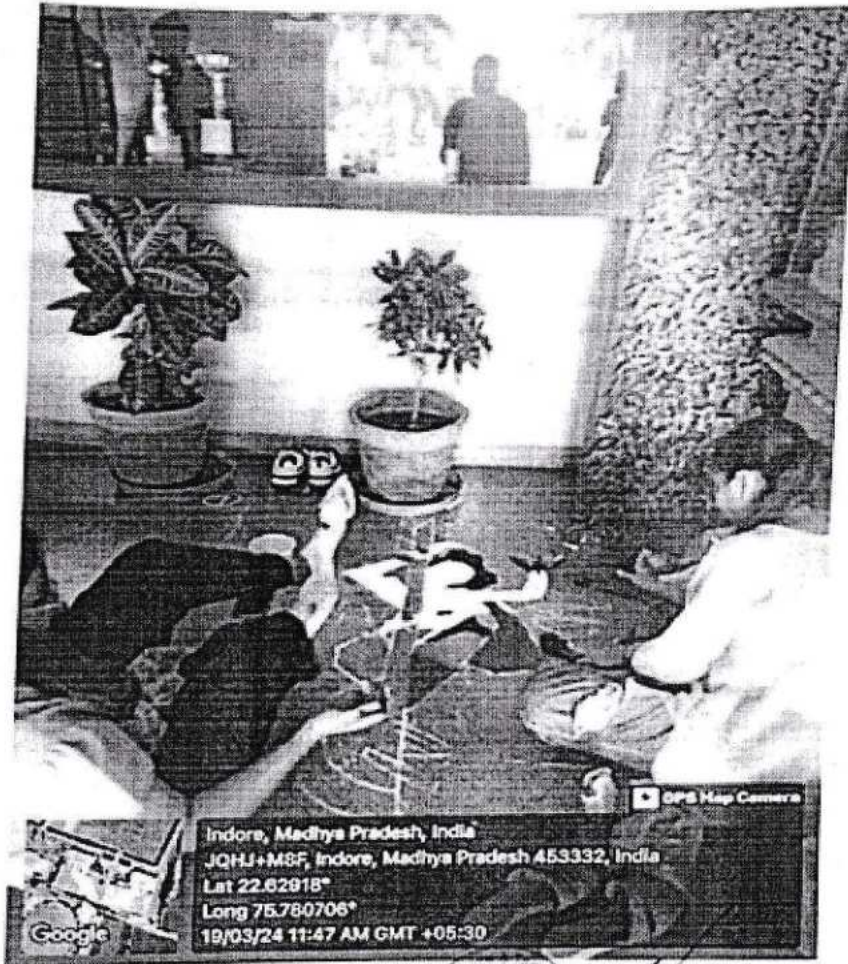

[Signature]
For IIST IIP/ IIMR
Chief Administrative Officer



[Signature]
Principal
Principal
Indore Institute of Science
& Technology, Indore
Saturday, December 21, 2024



IIST
Indore Institute of
Science & Technology

Indore Institute of Science & Technology

Approved by AICTE, New Delhi, Affiliated to RGPV, Bhopal, Recognized by UGC under Section 2(f)
2023-2024



Indore Institute of Science and Technology
Approved by AICTE, New Delhi & Affiliated to RGPV, Bhopal

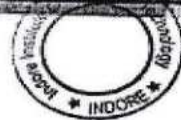
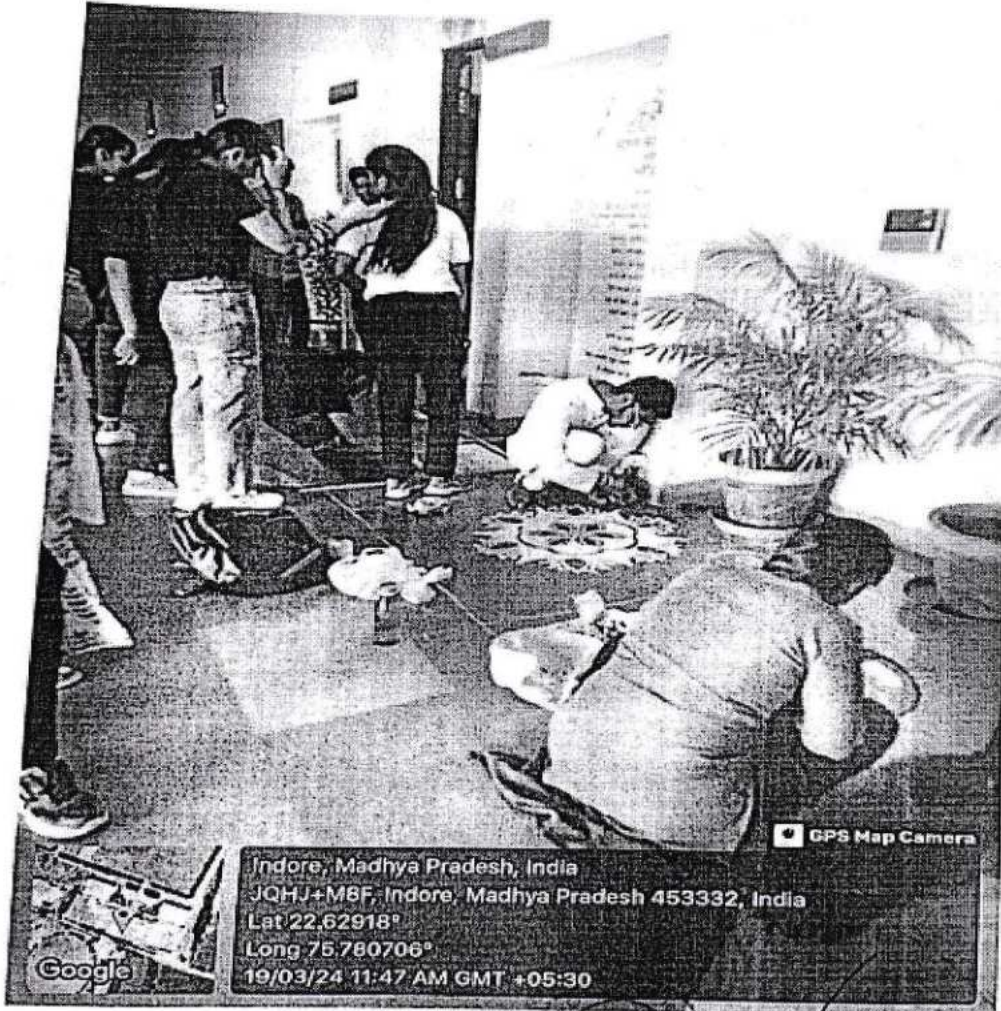

[Handwritten signature]

[Handwritten signature]
For IIST/ IIP/ IIMR
Chief Administrative Officer

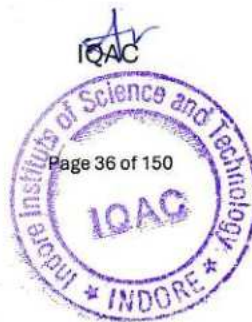

[Handwritten signature]
Principal
Principal
Indore Institute of Science
& Technology, Indore

Saturday, December 21, 2024



IIST
Indore Institute of
Science & Technology

Indore Institute of Science & Technology

Approved by AICTE, New Delhi, Affiliated to RGPV, Bhopal, Recognized by UGC under Section 2(f)
2023-2024

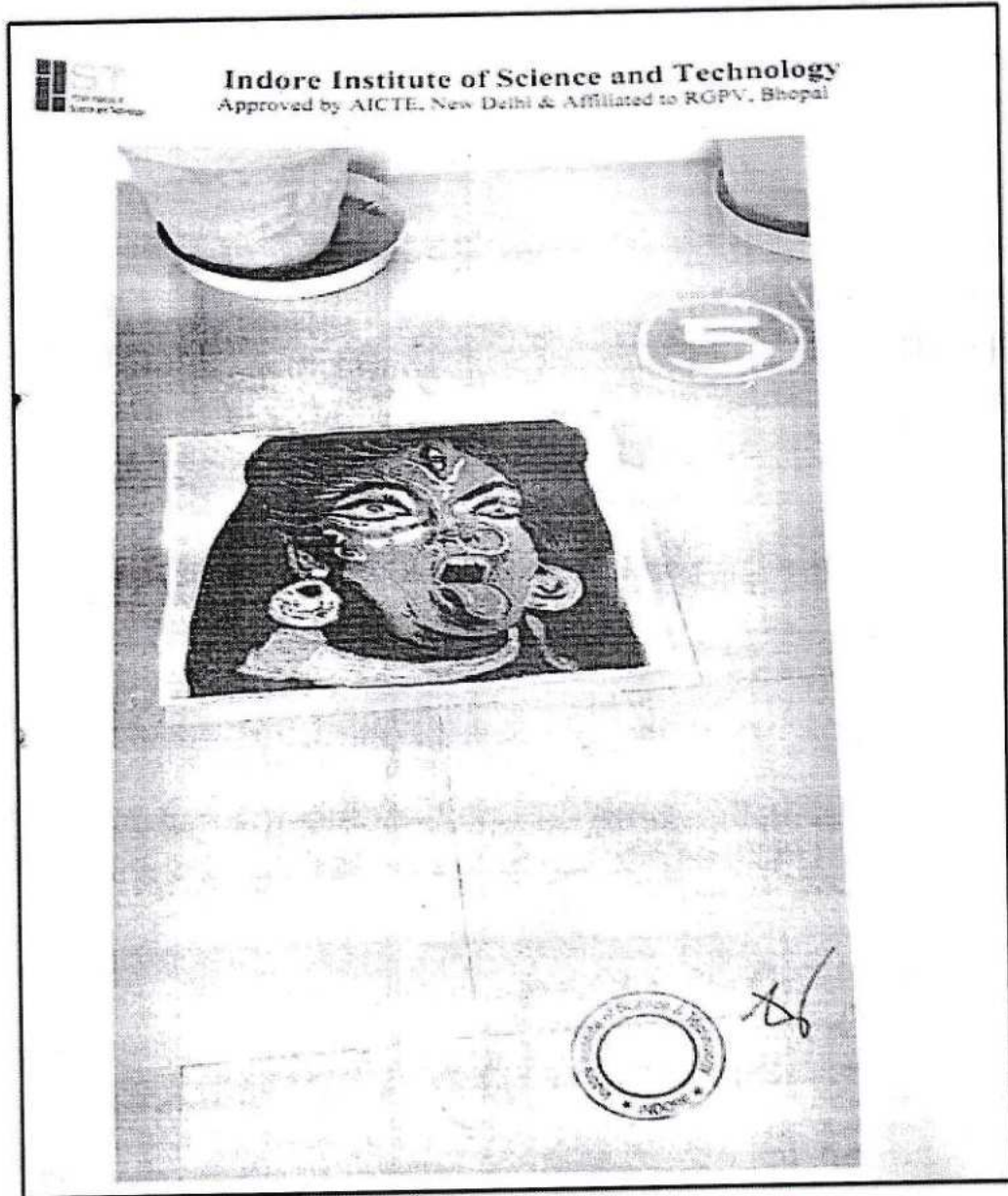

[Signature]
For IIST/ IIMR
Chief Administrative Officer



[Signature]
IQAC

[Signature]
Principal
Principal
Indore Institute of Science
& Technology, Indore
Saturday, December 21, 2024



IIST
Indore Institute of
Science & Technology

Indore Institute of Science & Technology

Approved by AICTE, New Delhi, Affiliated to RGPV, Bhopal, Recognized by UGC under Section 2(f)
2023-2024



Indore Institute of Science and Technology
Approved by AICTE, New Delhi & Affiliated to RGPV, Bhopal

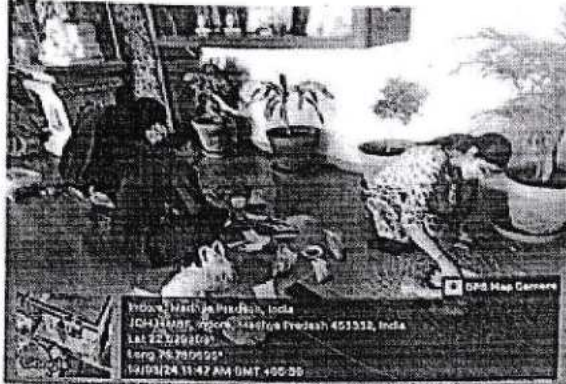

Handwritten signature

Handwritten signature
IQAC

Handwritten signature
For IIST/ IIP/ IIMK
Chief Administrative Officer



Handwritten signature
Principal
Principal
Indore Institute of Science
& Technology, Indore
Saturday, December 21, 2024



Indore Institute of Science & Technology

Approved by AICTE, New Delhi, Affiliated to RGPV, Bhopal, Recognized by UGC under Section 2(f) 2023-2024

4. Event Name-Drawing & Painting Competition Dated- 19th March 2024

Event Report-Drawing & Painting Competition



Indore Institute of Science and Technology

Approved by AICTE, New Delhi & Affiliated to RGPV, Bhopal

Event Report

Academic Year: 2023-24 Sessions: Jan- June 2024

Name of Event: "Drawing & Painting Competition"

Theme of the Event: No theme

Date of Event: 19/03/2024

Organizing Dept.: Art Club, IIST

No. of Students Participated: 12

Event Coordinator: Poonam Bagora
Shanu Sharma
Sneha Nagar



Student Coordinators: 1. Mansi Awasthi 8269160153
2. Chandani Ahire 9039153409

Summary

On 19th March 2024, an event was organized with the participation of 12 students at IIST, IIP and IIMR in Dazzle 2024. There is no theme it is open for all to show their creativity. A drawing competition without a specific theme allows participants the freedom to explore their creativity without constraints. Artists are encouraged to showcase their skills and imagination through their drawings, using any medium or style of their choice. The absence of a theme allows for a diverse range of artworks, each reflecting the individuality and unique perspective of the artist.

Participants are given a set timeframe to create their drawings, which can vary depending on the competition's rules. Judging criteria typically focus on aspects such as creativity, originality, technical skill, composition, and overall impression. Judges may include professional artists, art educators, or experts in the field. Drawing competitions without a theme provide artists with a platform to express themselves freely, receive feedback, and gain exposure within the artistic community.

Overall, such competitions serve as a celebration of artistry and creativity, fostering a supportive environment for artists to share their passion for drawing and engage with like-minded individuals.

For IIST/ IIP/ IIMR
Chief Administrative Officer



Principal
Indore Institute of Science
Indore
Saturday, December 21, 2024



I. Drawing & Painting Competition



Indore Institute of Science and Technology

Approved by AICTE, New Delhi & Affiliated to RGPV, Bhopal

Event Highlights:

The event began with an inaugural session by Director General, Shri Arun.S.Bhatnagar. They addressed our faculty members, staff along with youth of today our students.

Conclusion:

The event witnessed the active participation of 12 students who demonstrated their dedication to Art. They expressed their thoughts and art by Drawing and painting.

FB link -

<https://www.facebook.com/100064495487764/posts/pfbid0KcYCErtSxDTgFNzi9SMPruFe5ykdz564w9YwzekLucHaJMdacXRMDYXJyiSW4ofEJ/>

Instagram Link :

<https://www.instagram.com/reel/C4nnpkxeT2/?igsh=NTc4MTIwNjQ2YQ==>

The Winners are-

1. Ritika Prasad
2. Jatin Kadam
3. Happy Sharma
4. Vanshika Nagde

Event Coordinators

Poonam Bagora

Shanu Sharma

Sneha Nagar



Principal
Principal

Indore Institute of Science
and Technology, Indore



Principal
Principal

Indore Institute of Science
and Technology, Indore

Saturday, December 21, 2024

For IIST/IIP/IIMK

Chief Administrative Officer





J. Drawing & Painting Competition Approval



Indore Institute of Science and Technology
Approved by AICTE, New Delhi & Affiliated to RGPV, Bhopal

Approval Letter

Date: 29/10/23

Respected Sir,

We are planning to organise an event at IIST ,IIP, IIMR of a Drawing compition in Dazzle 2024 on 19th march 2024 for all the students and faculty and staff members of IIST Group of Institute.

Kindly approve the same for conducting the activity.

HOD/COORDINATOR:



PRINCIPAL

Principal
Indore Institute of Science
& Technology, Indore

For IIST, IIP/ IIMR

Chief Administrative Officer



Principal
Indore Institute of Science
and Technology, Indore
Saturday, December 21, 2024



K. Drawing & Painting Competition Notice

 **Indore Institute of Science and Technology**
Approved by AICTE, New Delhi & Affiliated to RGPV, Bhopal

DATE: 06/03/2024

NOTICE

This is to inform all the students, faculty and staff members of IIST group on institutes that an event was organized at IIST ,IIP and IIMR in dazle 2024 on 19th march 2024. There is no theme, it is open for all to show their creativity.

Faculty Coordinator:

POONAM BAGORA
SHANU SHARMA
SNEHA NAGAR

HOD /  COORDINATOR



 PRINCIPAL

Principal
Indore Institute of Science
and Technology, Indore

L. Drawing & Painting Competition | Glimpse of the Event

For IIST, IIP, IIMR
Chief Administrative Officer

IQAC

Page 43 of 150

Principal
Principal
Indore Institute of Science
Saturday, December 21, 2024



IIST
Indore Institute of
Science & Technology

**Indore Institute of
Science & Technology**

Approved by AICTE, New Delhi, Affiliated to RGPV, Bhopal, Recognized by UGC under Section 2(f)
2023-2024



Indore Institute of Science and Technology
Approved by AICTE, New Delhi & Affiliated to RGPV, Bhopal

Glimpse of the Event

Poster Circulated among Students

Dazzle 2k24 Annual Function

15 March 2024
FILMOTSAV
Mr. Ansh Jain - 98275 98277 | Mr. Parvati Duggal - 98933 82082

18 March 2024
INTER COLLEGE SPORTS (9:30 am - 4:00 pm)
Dr. Tejaswini Bhatnagar - 9994659051

18-19 March 2024
HACKATHON (24 hrs)
Dr. Megh Patel - 97333 82926

18-20 March 2024
RANGOLI, PHOTOGRAPHY, FILM MAKING,
DRAWING & PAINTING
Dr. Renu Agrawal - 92230 88893 | Dr. Priyanka Doshi - 83580 94296
Ms. Poojara Duggal - 98246 18848 | Dr. Ansh Jain - 98275 98277

20 March 2024
ROBO RACE (9:30 am - 12:00 noon)
Mr. Ashish Mishra - 98936 34742

IDEATHON (10:00 am - 11:00 am)
Mr. Ashish Mishra - 98936 34742

MODEL PARLIAMENT (10:00 am - 04:00 pm)
Dr. Vinita Dabhiwal - 98767 79379

21 March 2024
CULTURAL & FASHION SHOW (9:30 am - 01:00 pm)
Dr. Renu Agrawal - 92230 88893
(Sports Begins 1:00 pm - 03:00 pm)

BOLLYWOOD MUSIC EVENING (3:30 pm - 05:00 pm)
Ms. Saveri Dabhi

22 March 2024
QUIZ (10:00 am - 11:30 pm)
Dr. Parvati Duggal - 98275 98277 | Dr. Vinita Dabhi - 98767 79379

POETRY (3:30 pm - 01:00 pm)
Dr. Ansh Jain - 98275 98277

FAAG UTSAV (HOLI) (2:30 pm - 04:00 pm)
Ms. Megh Patel - 97333 82926

Opp. IIM Indore, Rau-Pithampur Road, Rau, Indore (MP)
Toll Free: 1800 183 3068 | www.indoreinstitute.com
822 547 1900/2000/3000 / 822 407 1000/2000

(Handwritten signatures and a circular stamp)

(Handwritten signature)
For IIST/ IIP/ IIMR
Chief Administrative Officer



(Handwritten signature)
Principal
Indore Institute of Science
Saturday, December 21, 2024



1. Drawing & Painting Competition Glimpse

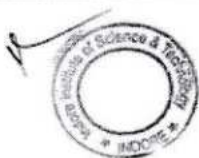

[Signature]
For IIST/ IIR/ IIMR
Chief Administrative Officer



[Signature]
Principal
Principal
Indore Institute of Science
& Technology, Indore
Saturday, December 21, 2024



IIST
Indore Institute of
Science & Technology

**Indore Institute of
Science & Technology**

Approved by AICTE, New Delhi, Affiliated to RGPV, Bhopal, Recognized by UGC under Section 2(f)
2023-2024

2. Drawing & Painting Competition Glimpse

IIST
Indore Institute of
Science & Technology

Indore Institute of Science and Technology
Approved by AICTE, New Delhi & Affiliated to RGPV, Bhopal

Indore, Madhya Pradesh, India
JQHJ+M8F, Indore, Madhya Pradesh 453332, India
Lat 22.629022°
Long 75.781165°
19/03/24 03:10 PM GMT +05:30

GPS Map Covers

Google

[Signature]
For IIST / IIP / IIMR

Chief Administrative Officer



[Signature]
Principal
Indore Institute of Science
and Technology, Indore
Saturday, December 21, 2024



3. Drawing & Painting Competition Glimpse

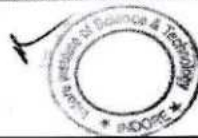
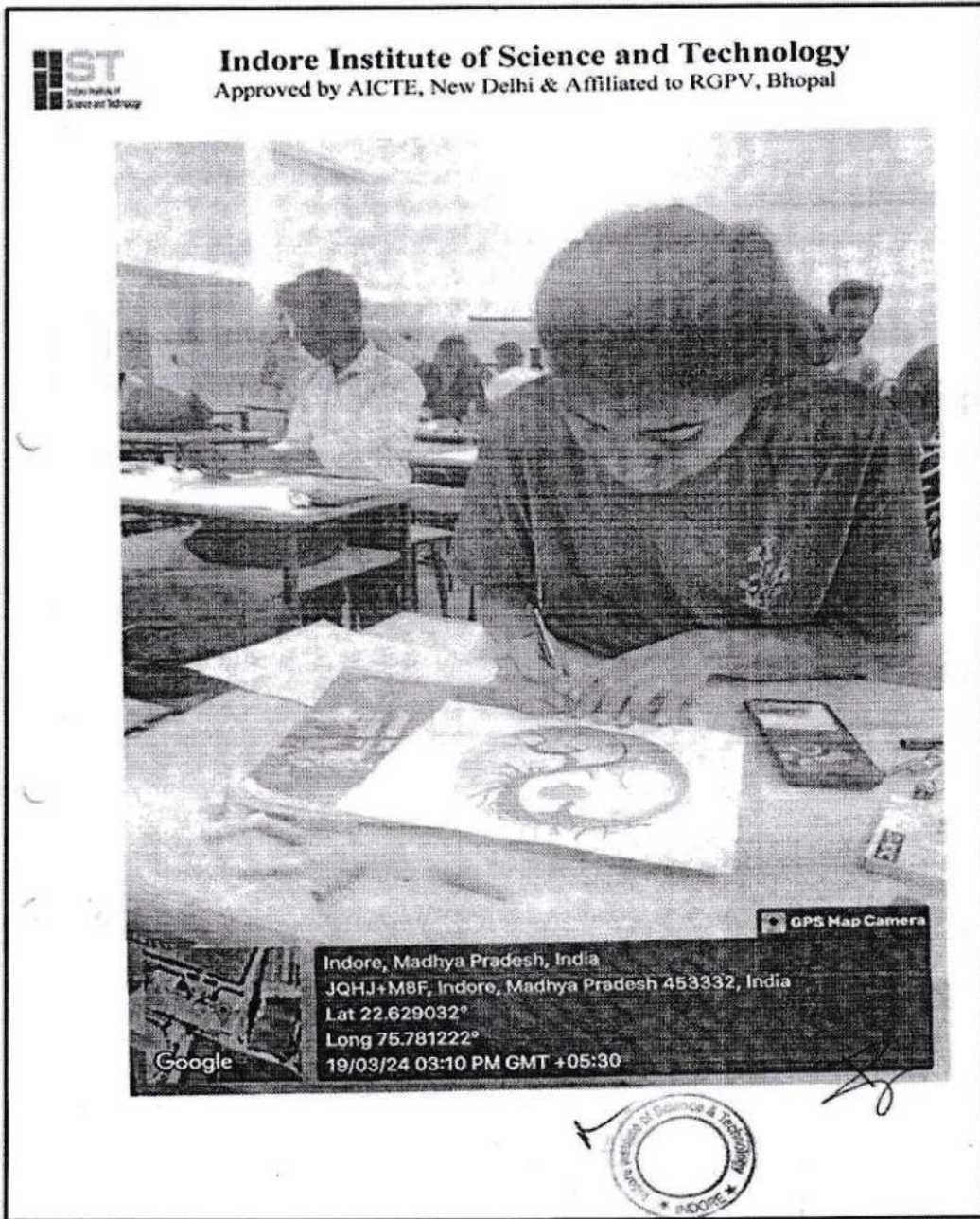

[Signature]
For IIST/ IIP/ IIMR
Chief Administrative Officer

[Signature]
IQAC

[Signature]
Principal

Indore Institute of Science
and Technology, Indore

Saturday, December 21, 2024





4. Drawing & Painting Competition Glimpse

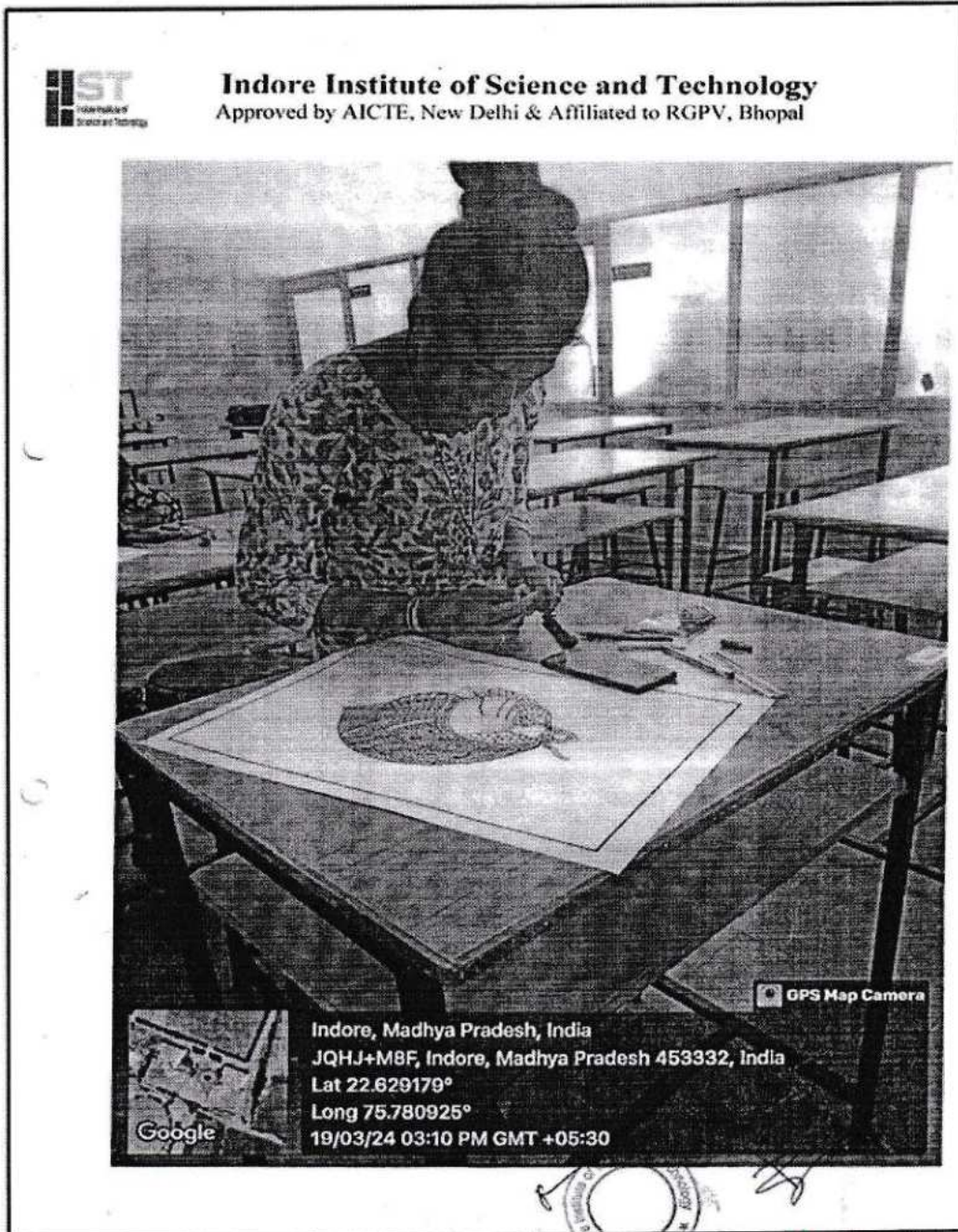

[Signature]
For IIST / IIP / IIMR
Chief Administrative Officer



[Signature]
Principal
Indore Institute of Science
and Technology, Indore
Saturday, December 21, 2024



IIST
Indore Institute of
Science & Technology

**Indore Institute of
Science & Technology**

Approved by AICTE, New Delhi, Affiliated to RGPV, Bhopal, Recognized by UGC under Section 2(f)
2023-2024

5. Drawing & Painting Competition Glimpse

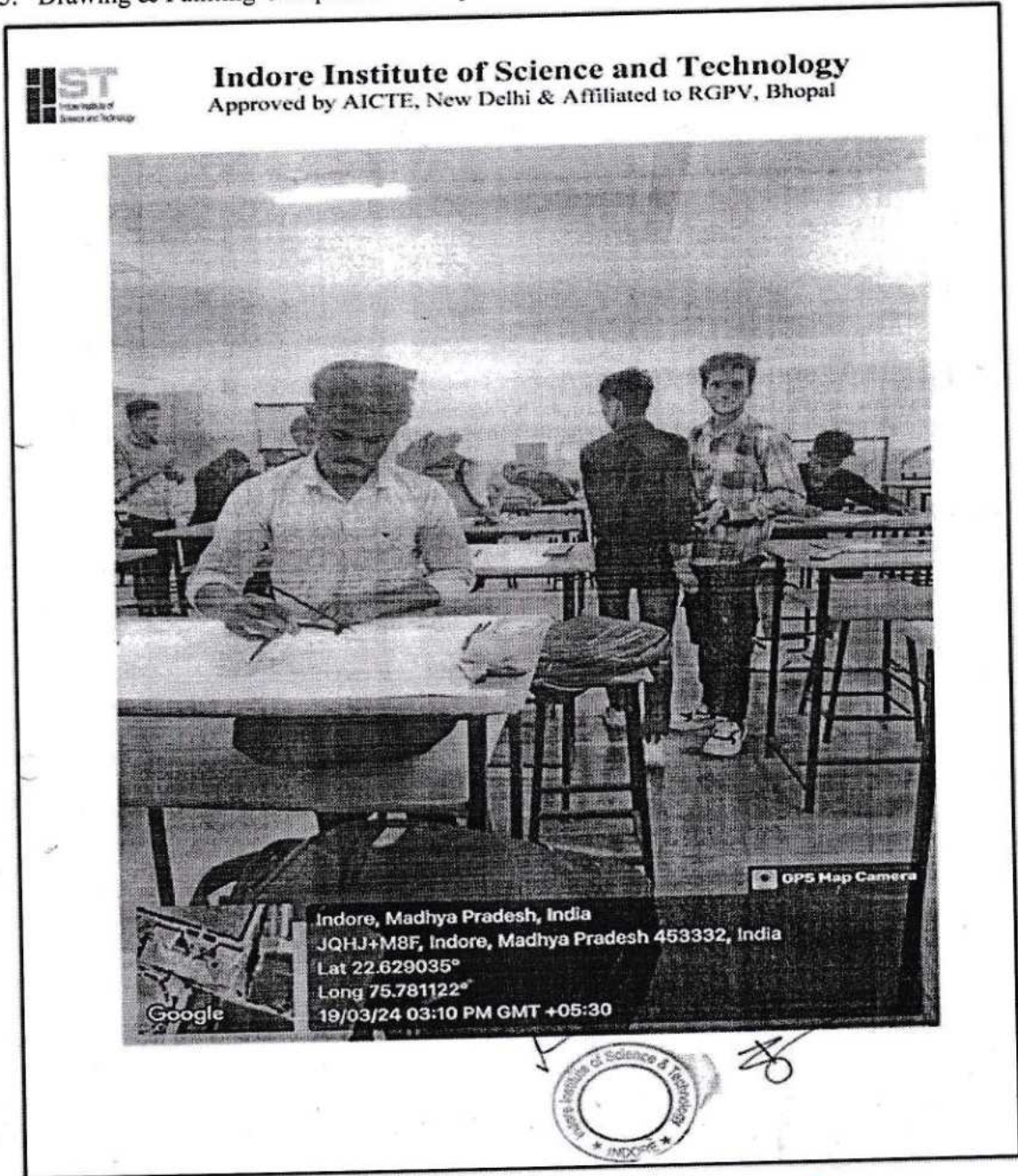

For IIST/
Chief Administrative Officer



Principal
Indore Institute of Science
Technology, Indore
Saturday, December 21, 2024



6. Drawing & Painting Competition Glimpse

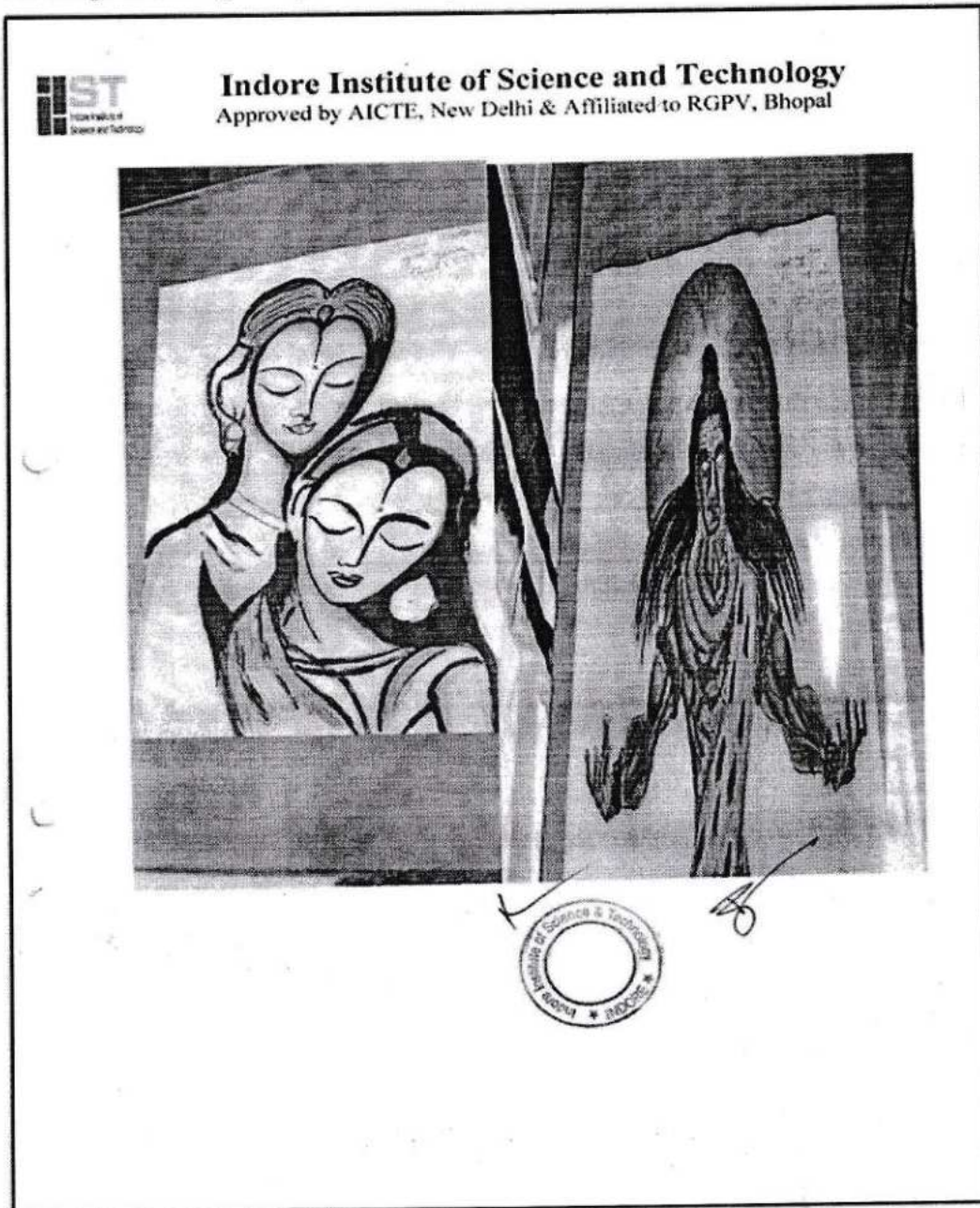

For IIST/ IIP/ IIMR
[Signature]
Chief Administrative Officer



[Signature]
Principal
Principal
Indore Institute of Science
& Technology, Indore
Saturday, December 21, 2024



Indore Institute of Science & Technology

Approved by AICTE, New Delhi, Affiliated to RGPV, Bhopal, Recognized by UGC under Section 2(f) 2023-2024

5. Event Name – Rangoli Competition

Dated-9th November 2023

Event Report-Rangoli Competition



Indore Institute of Science and Technology
Approved by AICTE, New Delhi & Affiliated to RGPV, Bhopal

Event Report

Academic Year: 2023-24 Sessions: July-Dec 2023

Name of Event: "Rangoli Competition"

Theme of the Event: "Cultural/Traditional"

Date of Event: 9th November 2023

Organizing Dept.: Art Club, IIST

No. of Students Participated: 09

Event Coordinator: Poonam Bagora
Shanu Sharma

Student Coordinators: 1. Mansi Awasthi 8269160153
2. Pratham Tomar 7415374235

Summary

On 9th November 2023, an event was organized with the participation of 09 students at Indore Institute of Science & Technology. The theme of the event was "Cultural/Traditional", and it aimed to bring forward awareness about Indian culture.

Event Highlights:

The event began with an inaugural session by Director General, Shri Arun S Bhatnagar. They addressed our faculty members, staff along with youth of today our students.

Conclusion:

The event witnessed the active participation of 09 students who demonstrated their dedication to Art. They expressed their thoughts and art by "Cultural/Traditional" Rangolis. Students had expressed their creativity, culture, and colors in the most vibrant way.

FB link --
<https://www.facebook.com/100064495487764/posts/pfbid02EGRB21HZ19xsbFUCqaLN8VYVQaFSaUSh23u6QKFMx3wydifeuX4uXciLQm98SxBQI>



For IIST/IIP/ IIMR
Chief Administrative Officer



Principal
Principal
Indore Institute of Science
and Technology, Indore
Saturday, December 21, 2024



N. Rangoli Competition

IIST
Indore Institute of
Science & Technology

Indore Institute of Science and Technology
Approved by AICTE, New Delhi & Affiliated to RGPV, Bhopal

Instagram Link :
<https://www.instagram.com/p/CzhrUcwM5ox/?igshid=NTe4MTIwNiQ2YQ==>

The Winners are-

1. Pritee singh CS- I year
2. Neha Sharma CS - II year
3. Ankush Sardiya IT- III year
4. Nishita Kanojiya AIML- III year

Event Coordinators
Poonam Bagora *Poonam*
Shanu Sharma *Shanu*
29.11.23

[Signature]
Principal-IIST
Indore Institute of Science
& Technology, Indore

[Signature]
Principal
Indore Institute of Science
& Technology, Indore

[Signature]
Principal
Indore Institute of Science
& Technology, Indore

[Signature]
For IIST/IPP/ IIMR
Chief Administrative Officer



[Signature]
Principal
Indore Institute of Science
& Technology, Indore

Saturday, December 21, 2024



O. Rangoli Competition Approval

 **IIST** Indore Institute of Science & Technology



INDORE INSTITUTE OF SCIENCE & TECHNOLOGY
Approved by: AICTE, New Delhi & Affiliated to RGPV, Bhopal

Approval & Note Sheet Date: 5/11/23

As per our tradition we celebrate the festival of Diwali with great zeal along with cultural program at Indore Institute of Science & Technology on 9th Nov. 2K23 for all the Faculty & staff members. Details of arrangements required are as follows –

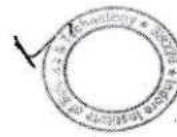
1. Auditorium with sound Arrangements
2. Rangoli Colours
3. Flowers for decoration



 Coordinators

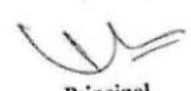

 Principal
 Indore Institute of Science and Technology, Indore

 For IIST/ IIMR
 Chief Administrative Officer

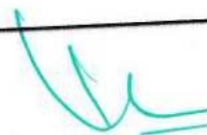

 Principal
 Indore Institute of Science and Technology, Indore
 Saturday, December 21, 2024



Indore Institute of Science & Technology

Approved by AICTE, New Delhi, Affiliated to RGPV, Bhopal, Recognized by UGC under Section 2(f)
2023-2024

P. Rangoli Competition Notice



Indore Institute of Science and Technology
Approved by AICTE, New Delhi & Affiliated to RGPV, Bhopal

DATE: 06/11/2023

NOTICE

This is to inform all the students , faculty and staff members of IIST Group of Institutes that an event was organized for the Rangoli, competition (Cultural / Traditional) on 9th Nov 2023 .

Faculty Coordinator:

Poonam Bagora
Shanu sharma

HOD / COORDINATOR



PRINCIPAL
Principal
Indore Institute of Science
and Technology, Indore

FOR IIST/ IIP/ IIMR

Chief Administrative Officer



Principal

Principal
Indore Institute of Science
and Technology, Indore

Saturday, December 21, 2024



IIST
Indore Institute of
Science & Technology

**Indore Institute of
Science & Technology**

Approved by AICTE, New Delhi, Affiliated to RGPV, Bhopal, Recognized by UGC under Section 2(f)
2023-2024

Q. Rangoli Competition Glimpse of the Events



Indore Institute of Science and Technology
Approved by AICTE, New Delhi & Affiliated to RGPV, Bhopal

Glimpse of the Event

Poster Circulated among Students



**Indore Institute of
Science & Technology**

AICTE Approved | Affiliated to RGPV, Bhopal

Organizing

दीप
पर्व
2023

*Rangoli
Competition*

Date: 09th Nov., 2023
Time: 11:00 AM | Venue: B-Block @ IIST

Faculty Coordinators:
Ms. Shama Sharma | Ms. Poonam Bagora

Student Coordinators:
Manal Anandhi | Pratham Tomar

IIST Campus, Opp. IIM (Indore), Rev. Pithampur Road, Rev. Indore 453331 (M.P.)
www.indoreinstitute.com | info@indoreinstitute.com | www.facebook.com/IIST.collegeindore/
Toll Free: 1800 102 3889 | 822 407 1000/2000 | 822 507 2000/3000





IQAC

Principal

Indore Institute of Science
and Technology, Indore

Saturday, December 21, 2024

For IIST/ IIR/ IIMR

Chief Administrative Officer





R. Rangoli Competition

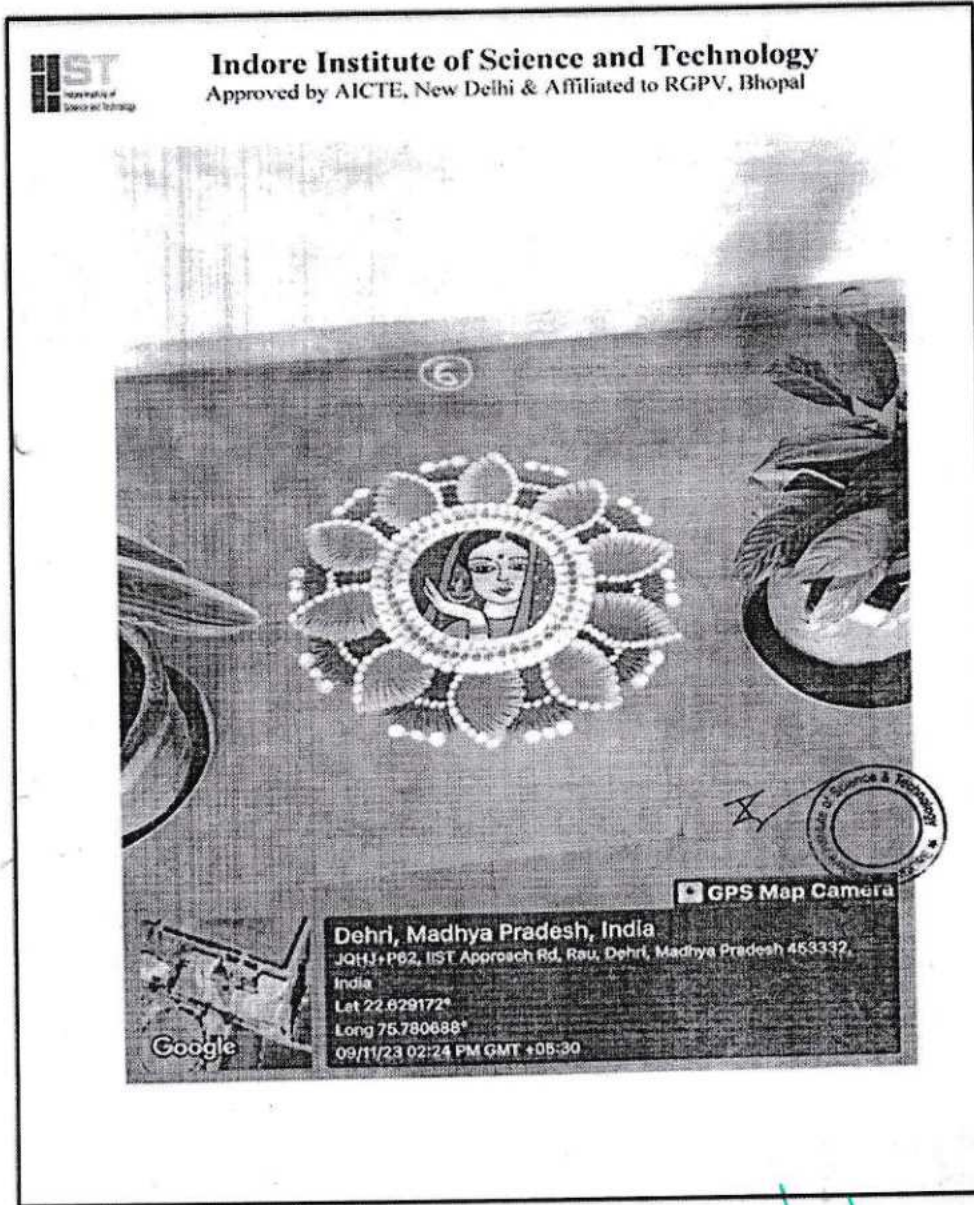

[Signature]
 For IIST/ IIR/ IIMR
 Chief Administrative Officer



[Signature]
 Principal
 Indore Institute of Science
 and Technology, Indore

Saturday, December 21, 2024



IIST
Indore Institute of
Science & Technology

Indore Institute of Science & Technology

Approved by AICTE, New Delhi, Affiliated to RGPV, Bhopal, Recognized by UGC under Section 2(f)
2023-2024

S. Rangoli Competition

Indore Institute of Science and Technology
Approved by AICTE, New Delhi & Affiliated to RGPV, Bhopal

Indore, Madhya Pradesh, India
JQHJ+MBF, Indore, Madhya Pradesh 453332, India
Lat 22.629177°
Long 75.780769°
09/11/23 12:12 PM GMT +05:30

GPS Map Camera

Google

[Signature]
For IIST/ IPT/ IIMR
Chief Administrative Officer

[Signature]
IQAC

[Signature]

Principal

Principal
Indore Institute of Science
and Technology, Indore



Saturday, December 21, 2024



IIST
Indore Institute of
Science & Technology

**Indore Institute of
Science & Technology**

Approved by AICTE, New Delhi, Affiliated to RGPV, Bhopal, Recognized by UGC under Section 2(f)
2023-2024

T. Rangoli Competition

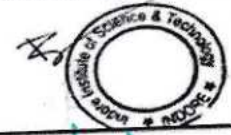
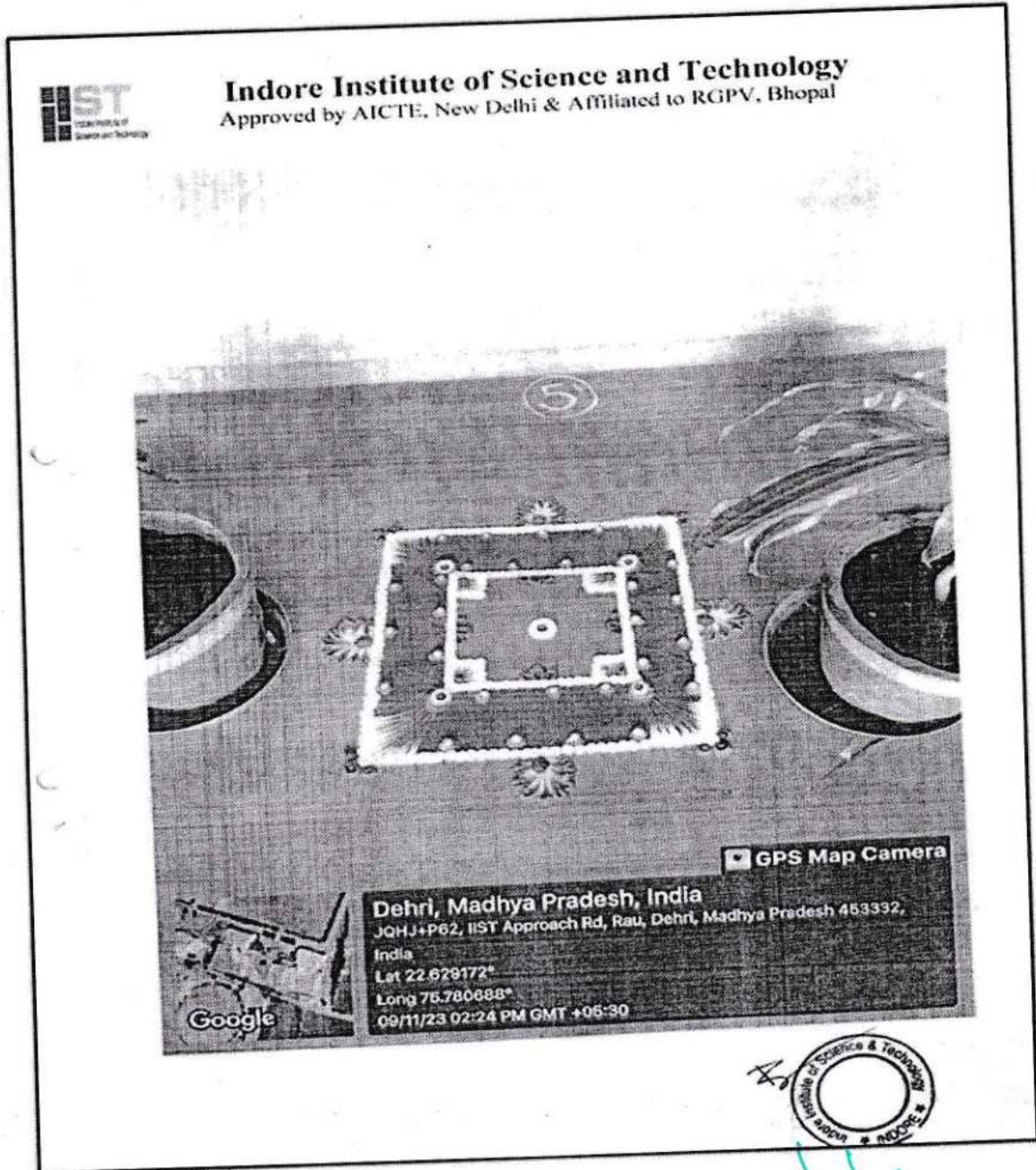

[Signature]
For IIST/ IIP/ IIMR

Chief Administrative Officer

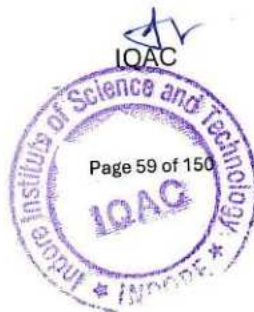

Principal

Principal

Indore Institute of Science
& Technology, Indore

Saturday, December 21, 2024



U. Rangoli Competition

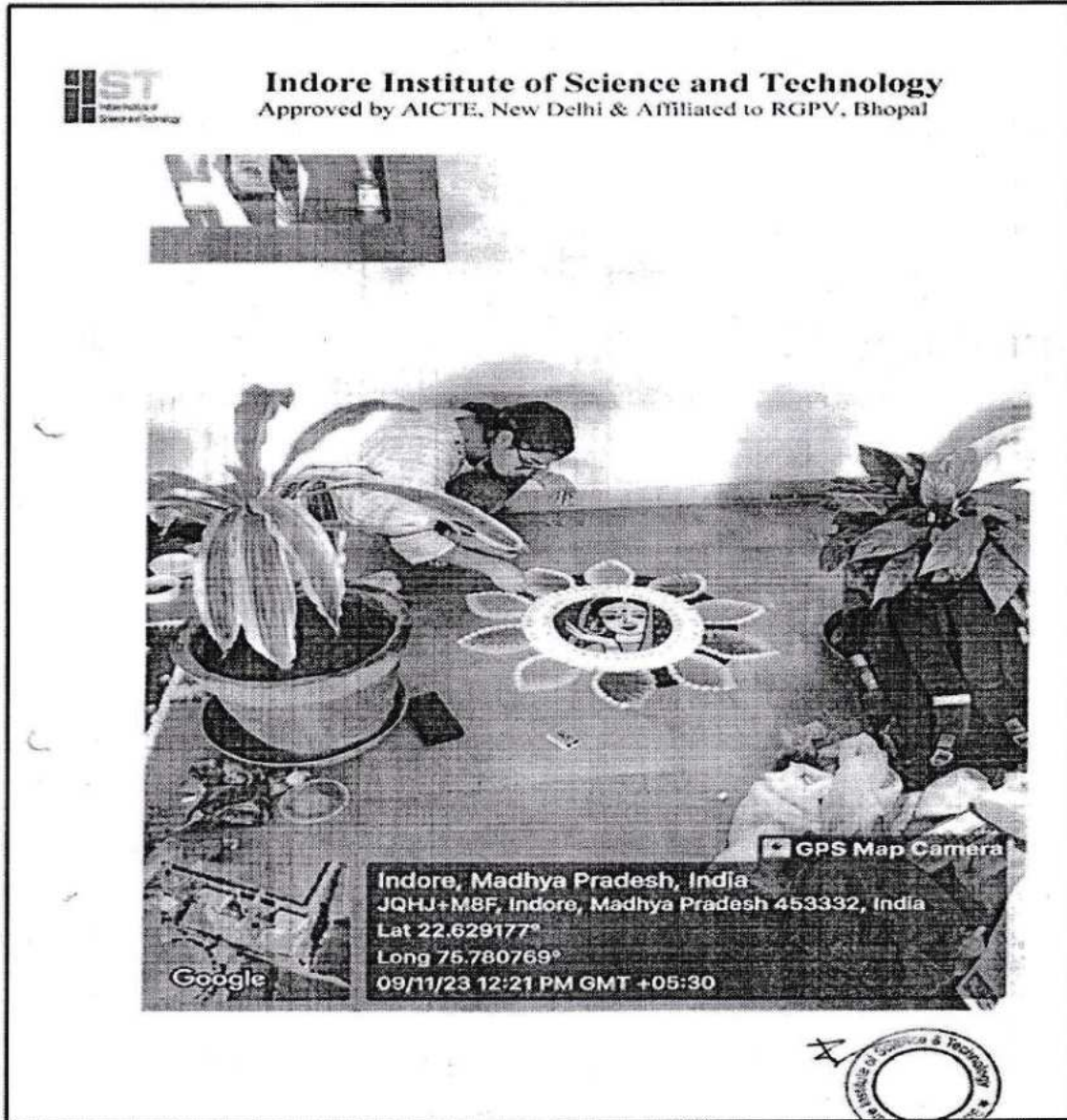

[Signature]
For IIST/IPP/IIMR
Chief Administrative Officer

IQAC



[Signature]
Principal

Indore Institute of Science
and Technology, Indore

Saturday, December 21, 2024



IIST
Indore Institute of
Science & Technology

**Indore Institute of
Science & Technology**

Approved by AICTE, New Delhi, Affiliated to RGPV, Bhopal, Recognized by UGC under Section 2(f)
2023-2024

V. Rangoli Competition

Indore Institute of Science and Technology
Approved by AICTE, New Delhi & Affiliated to RGPV, Bhopal

[Signature]
For IIST/ IPI/ IIMR
Chief Administrative Officer

[Signature]
IQAC
Page 61 of 150
Indore Institute of Science and Technology
IQAC
Indore

[Signature]
Principal
Principal
Indore Institute of Science
and Technology, Indore
Saturday, December 21, 2024



IIST
Indore Institute of
Science & Technology

Indore Institute of Science & Technology

Approved by AICTE, New Delhi, Affiliated to RGPV, Bhopal, Recognized by UGC under Section 2(f)
2023-2024

W. Rangoli Competition

IIST Indore Rangoli Competition-2023
09th NOV^r 2023

Date: _____
P. No: _____

Name	Rangoli no	Branch	Co. No.	Sign
1 st Ankush Sardija (1)	IT	1 st	7225037045	<i>Ankush</i>
Prachi Singh (2)	ITML	1 st	8839007145	<i>Prachi</i>
Aarushi Verma (3)	CSE (AI)	1 st	9165759768	<i>Aarushi</i>
Anshika Sharma (4)	CSE (AI)	1 st	7974806928	<i>Anshika</i>
2 nd Neha Sharma (6)	CSE A2	1 st	8077947050	<i>Neha</i>
Komal Kable (7)	CSE A2	I & E	9630289867	<i>Komal</i>
1 st Pooja Singh (8)	CSE A2	1 st	9425620814	<i>Pooja</i>
APARNA BHAND (9)	ITML	3 rd	9827099322	<i>Aparna</i>
3 rd Nishita Kamajiy (4)	ITML	1 st	8770266294	<i>Nishita</i>

[Signature]

[Signature]
FOR IIST/ IIP/ IIMR
Chief Administrative Officer



[Signature]
Principal
Indore Institute of Science

Saturday, December 21, 2024



6. Event- National Girl Child Day

National Girl Child Day- 25 Jan 2024

IIST
Indore Institute of
Science and Technology

Indore Institute of Science and Technology
Approved by AICTE, New Delhi & Affiliated to RGPV, Bhopal

Event Report

Academic Year: 2023 - 2024 Session: Jan-Jun 2024

Name of Event: National Girl Child Day

Date of Event: 25 Jan 2024

Topic/Theme: Awareness Session

No. of Participants: 29

Event Coordinator: Ms. Jaya Singh & Mr. Mahaveer Dangi

Student Coordinators: Ms. Sanjana Sen - EC III Year
Ms. Manisha - EC III Year



Summary

Indore Institute of Science & Technology organized a awareness session on 25 Jan at village Sindodi. The event was held with the aim of promoting awareness about empowering young girls and ensuring their holistic development and encouraging individuals to contribute to this noble cause. The event received overwhelming participation from students, faculty, and staff members.

The National Girl Child Day celebration on January 25th, 2024, brought widespread attention to the rights and empowerment of girls globally. The various activities, campaigns, and initiatives organized during this celebration served as catalysts for change, encouraging a more inclusive and equal society. Continued efforts and investment in the well-being and empowerment of girls are essential to creating a world where every girl can thrive and shape a better future.

Event Coordinators: *Jaya Singh*

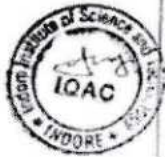
Principal
Indore Institute of Science and Technology

Sugge
For IIST/ IIP/ IIMR
Chief Administrative Officer



Jaya Singh
Principal
Indore Institute of Science and Technology

Saturday, December 21, 2024



X. National Girl Child Day- Approval & Notesheet- 21 May 2024



Approval & Note Sheet

Date: 21/5/24

At IIST we are willing to celebrate National Girl Child Day on 25th January 2024.
Around 35 students will be sent to village for awareness campaign based on the
theme. Details of requirements:

1. Bus for taking students to village - 1 No.
2. Refreshment arrangements - 40 persons
3. Banner on the theme
4. Memento for Sarpanch - 1 No

Coordinators



Principal
Principal
Indore Institute of Science
and Technology, Indore

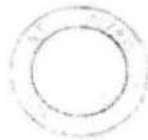

For IIST/ IIP/ IIMR
Chief Administrative Officer

IQAG



Principal
Indore Institute of Science
and Technology, Indore

Saturday, December 21, 2024



Y. National Girl Child Day-Notice- 23 Jan 2024

 **INDORE INSTITUTE OF SCIENCE & TECHNOLOGY**
Approved by AICTE, New Delhi & Affiliated to RGPV, Bhopal

NOTICE

Date: 23/01/24

This is to inform all that we are celebrating National Girl Child Day on 25th January 2024. Participating students are instructed to assemble near transport office at 10:00 AM. Bus will depart for village at sharp 10:30 AM.

Principal
Indore Institute of Science and Technology, Indore



For IIST/ IIP/ IIMR
Chief Administrative Officer



Principal

Principal
Indore Institute of Science
Saturday, December 21, 2024
Indore



IIST
Indore Institute of
Science & Technology

**Indore Institute of
Science & Technology**

Approved by AICTE, New Delhi, Affiliated to RGPV, Bhopal, Recognized by UGC under Section 2(f)
2023-2024

Z. Glimpse of National Girl Child Day





Indore Institute of Science and Technology
Approved by AICTE, New Delhi & Affiliated to RGPV, Bhopal

Glimpse of the event



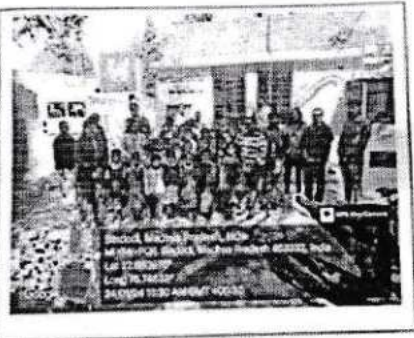





Loyal



[Signature]

Principal

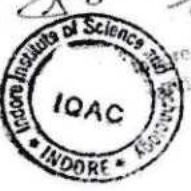

[Handwritten mark]

Principal

For *[Signature]*
Chief Administrative Officer

Page 66 of 150



Principal
Indore Institute of Science
and Technology, Indore

Saturday, December 21, 2024



AA. National Girl Child Day Attendance Sheet

CSE - III

INDORE INSTITUTE OF SCIENCE AND TECHNOLOGY					
EVENT NAME - NATIONAL GIRL CHILD DAY					
DATE OF EVENT: 18/12/23					
S.NO.	Name of Student	Year	Sec	Branch	Sign
1	Harianam Chaudhary	2023	7 th	CSE(A)	[Signature]
2	Dhruv Kishore	2023	1 st	CSE(A)	[Signature]
3	Pratik Gupta	2023	1 st	CSE(A)	[Signature]
4	Ajaya Singh Gadi	2023	1 st	CSE(A)	[Signature]
5	Kalpana Kulkarni	2023	1 st	CSE(A)	[Signature]
6	Ananya Singh	2023	1 st	CSE(A)	[Signature]
7	Deepika Bhandari	2023	1 st	CSE(A)	[Signature]
8	Aarushi Patel	2023	1 st	CSE(A)	[Signature]
9	Aarushi Verma	2023	1 st	CSE(A)	[Signature]
10	Anshika Jais	2023	1 st	CSE(A)	[Signature]
11	Chandupal Singh Rajput	2023	1 st	CSE(A)	[Signature]
12	Harshita Nagar	2023	1 st	CSE(A)	[Signature]
13	Ajaya Singh	2023	1 st	CSE(A)	[Signature]
14	Ujjwal Sheeth	2023	1 st	CSE(A)	[Signature]
15	Shreeharaj Chaudhary	2023	1 st	CSE(A)	[Signature]
16	Ganesh Sharma	2023	1 st	CSE(A)	[Signature]
17	Deepak Pandey	2023	1 st	CSE(A)	[Signature]
18	Amit Kumar	2023	1 st	CSE(A)	[Signature]
19	Chetan Yadav	2023	1 st	CSE(A)	[Signature]
20	Amitabh Ranjan	2023	1 st	CSE(A)	[Signature]
21	Shri Kulkarni	2023	1 st	CSE(A)	[Signature]
22	Aniket Yadav	2023	1 st	CSE(A)	[Signature]
23	Dhruv Singh	2023	1 st	CSE(A)	[Signature]
24	ARUN PAUL	2023	1 st	CSE(A)	[Signature]
25	Ananya Pandey	2023	1 st	CSE(A)	[Signature]
26	Chaitanya Kumar	2023	1 st	CSE(A)	[Signature]
27	Ankur Tiwari	2023	1 st	CSE(A)	[Signature]
28	Anshika Kishore	2023	1 st	CSE(A)	[Signature]
29	Bhavya Singh	2023	1 st	CSE(A)	[Signature]
30					
31					
32					
33					
34					
35					

[Signature]
For IIST/ IIP/ IIMR
Chief Administrative Officer



[Signature]
Principal
Indore Institute of Science and Technology, Indore
Saturday, December 21, 2024



BB. Faag Utsav- Approval & Note Sheet-19 march 2024



Approval & Note Sheet

On the Occasion of Holi festival, we wish to arrange a Music program Faag – Utsav and the Poetry Club “Abhivyanjana” is going to organize “Faag Mahotsav - Kavita, Shayari aur Geet on 22nd March 2024.

Details of requirements:

1. Small Stage at central ground
2. Sound arrangements
3. Auditorium II for Poetry
4. Collar Mic-02
5. Cordless Mic-03
6. Stand Mic-02
7. Prasad arrangement for 550 persons

Coordinators



Principal

Principal
Indore Institute of Science
and Technology, Indore

For IIST/ IIP/ IIMR

Chief Administrative Officer



Principal

Principal
Indore Institute of Science
and Technology, Indore



Saturday, December 21, 2024



Indore Institute of Science & Technology

Approved by AICTE, New Delhi, Affiliated to RGPV, Bhopal, Recognized by UGC under Section 2(f) 2023-2024

CC. Fagg Utsav- Notice- 18 March 2024



  **INDORE INSTITUTE OF SCIENCE & TECHNOLOGY**
Approved by AICTE, New Delhi & Affiliated to RGPV, Bhopal

NOTICE

Date: 18/3/24

This is to inform all that on the occasion of Holi festival A Fagg Utsav is being organized on 22nd March 2024 for all the students and staff members of Indore Institute of Science & Technology also Abivyanjana Club is organizing a Kavi sammelan. All are required to assemble at central ground at 2:00 PM.

Venue – Cafeteria
Time 2:30 PM onwards

  
Principal
Indore Institute of Science and Technology, Indore

For IIS/ IIP/ IIMR
Chief Administrative Officer



Principal
Indore Institute of Science and Technology, Indore
Saturday, December 21, 2024



DD. Glimpse & Social Link of Faag Utsav



Indore Institute of Science and Technology
Approved by AICTE, New Delhi & Affiliated to RGPV, Bhopal

Social Media Links

<https://www.facebook.com/100064295487764/posts/pfbidRZJNSZQz7a75P9U3LTVUpptodkEX4P1E3u6HpkWw6z2MmNSKxjknkZa8NAkasLpMB4DE>

<https://www.instagram.com/p/C48H-cRHInd-9p-d-NECpM1HvSgZ75Q/>

Glimpse of Event



Handwritten signature



Handwritten signature
Principal
Indore Institute of Science and Technology, Indore

Handwritten signature
For IIST/IIP/IIMR
Chief Administrative Officer



Handwritten signature
Principal
Indore Institute of Science and Technology, Indore
Saturday, December 21, 2024



EE.Glimpse of Faag Utsav

IIST
Indore Institute of Science and Technology
Approved by AICTE, New Delhi & Affiliated to RGPV, Bhopal

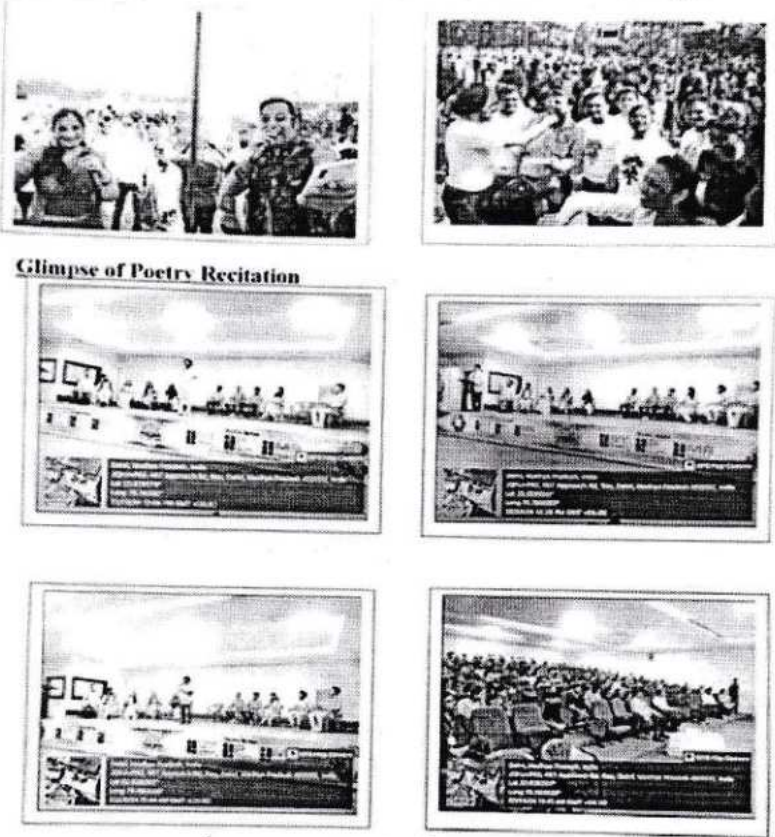

Glimpse of Poetry Recitation

Event Coordinator: *[Signature]*

Dr. Keshav Patidar
Principal IIST
Indore Institute of Science and Technology, Indore

[Circular Stamp: Indore Institute of Science and Technology IQAG]

For IIST / IIP / IIMR
[Signature]
Chief Administrative Officer

[Circular Stamp: Indore Institute of Science and Technology IQAG]
Page 72 of 150
INDORE

[Signature]
Principal
Indore Institute of Science and Technology, Indore
Saturday, December 21, 2024



FF. Event Details Of Faag Utsav



Event details:

- Faag Mahotsav (Kavita, Shayari aur Geet) 2K24
- Hosting organization: Abhivyajana club
- Date of event: 22/03/2024

Participants' List:

S. No.	Name of Participant	Institute	Course	Participation Status
1.	Raj Patil	IIST	CSE	Present ✓
2.	Yash Jholwar	IIST	CSE	Present ✓
3.	Adityavardhan Jain	IIST	AIML	Present ✓
4.	Neelesh Bhargava	IIST	IT	Present ✓
5.	Snoha Chouhan	IIST	CSE	Present ✓
6.	Shubhi Tiwari	IIST	CSE	Present ✓
7.	Shridhara Patel	IIST	CSE	Present ✓
8.	Dhairya Verma	IIST	DS	Present ✓

9.	Rohit Indori	IIP	B. Pharma	Present ✓
10.	Kulshresth Sharma	IIP	B. Pharma	Present ✓
11.	Saumya Katiyar	IIP	B. Pharma	Present ✓
12.	Sagar Kushwaha	IIP	B. Pharma	Present ✓
13.	Dheeraj Khandelwal	IIMR	BBA	Present ✓

For IIST/ IIP/ IIMR

Chief Administrative Officer

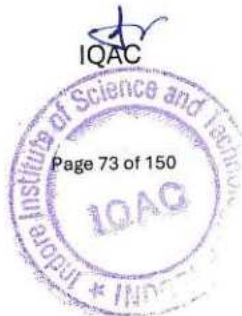

Principal
Indore Institute of Science
and Technology Indore

Saturday, December 21, 2024



Faag Utsav Attendance Sheet Record-1

INDORE INSTITUTE OF SCIENCE & TECHNOLOGY
NAME OF ACTIVITY: FAAG UTSAV - 20/12/24

S.No	Name	Year	Branch
1	AARON A SHARMA	CSE	P
2	AARON A SHARMA	CSE	P
3	AARON A SHARMA	CSE	P
4	AARON A SHARMA	CSE	P
5	AARON A SHARMA	CSE	P
6	AARON A SHARMA	CSE	P
7	AARON A SHARMA	CSE	P
8	AARON A SHARMA	CSE	P
9	AARON A SHARMA	CSE	P
10	AARON A SHARMA	CSE	P
11	AARON A SHARMA	CSE	P
12	AARON A SHARMA	CSE	P
13	AARON A SHARMA	CSE	P
14	AARON A SHARMA	CSE	P
15	AARON A SHARMA	CSE	P
16	AARON A SHARMA	CSE	P
17	AARON A SHARMA	CSE	P
18	AARON A SHARMA	CSE	P
19	AARON A SHARMA	CSE	P
20	AARON A SHARMA	CSE	P
21	AARON A SHARMA	CSE	P
22	AARON A SHARMA	CSE	P
23	AARON A SHARMA	CSE	P
24	AARON A SHARMA	CSE	P
25	AARON A SHARMA	CSE	P
26	AARON A SHARMA	CSE	P
27	AARON A SHARMA	CSE	P
28	AARON A SHARMA	CSE	P
29	AARON A SHARMA	CSE	P
30	AARON A SHARMA	CSE	P
31	AARON A SHARMA	CSE	P
32	AARON A SHARMA	CSE	P
33	AARON A SHARMA	CSE	P
34	AARON A SHARMA	CSE	P
35	AARON A SHARMA	CSE	P
36	AARON A SHARMA	CSE	P
37	AARON A SHARMA	CSE	P
38	AARON A SHARMA	CSE	P

FOR IIST / IIMR
Chief Administrative Officer



Principal
Principal
Indore Institute of Science
and Technology Indore
Saturday, December 21, 2024



Faag Utsav Attendance Sheet Record-2

39	ANUJ PANWAR	CSE	P
40	ANUJ PATEL	CSE	P
41	ANURAG PANDEY	CSE	P
42	ANURAG LAMBHAR	CSE	P
43	ANURAG VERMA	CSE	P
44	ARUN SINGH BHATE	CSE	P
45	ARUN	CSE	P
46	ATHARV RATHORE	CSE	P
47	ATHARV SHARMA	CSE	P
48	ATUL PORWAL	CSE	P
49	AVI MISHRA	CSE	P
50	AVINASH SAHU	CSE	P
51	AYUSH YADAV	CSE	P
52	BHAWESH DAWANDE	CSE	P
53	CHAITANYA KUMAR	CSE	P
54	CHANDRAPAL SINGH RAJPUT	CSE	P
55	CHETAN	CSE	P
56	DEEP TIROLE	CSE	P
57	DEEPAK PANDEY	CSE	P
58	DEEPIKA BAMNIYA	CSE	P
59	DEVANSHU SHARMA	CSE	P
60	DHANRAJ	CSE	P
61	DHEERAJ CHOUDHARY	CSE	P
62	DHEERAJ INDRIYA	CSE	P
63	DHEERAJ KUSHWAHA	CSE	P
64	DIPESH SHAKYAWAR	CSE	P
65	DISHA GUPTA	CSE	P
66	FALGUNI KALBHUT	CSE	P
67	FEJAN RAJAWAT	CSE	P
68	GARVIT SHARMA	CSE	P
69	GAURAV KUMAR	CSE	P
70	GAURI NEEMA	CSE	P
71	GAUTAM SHARMA	CSE	P
72	GEETIKA PATHAK	CSE	P
73	GORANK KANUGO	CSE	P
74	HARDIK DERASHRI	CSE	P
75	HARIOM CHAUDHARY	CSE	P
76	HARIOM NAGAR	CSE	P
77	HARSH KALA	CSE	P
78	HARSH MAKWANA	CSE	P
79	HARSH PAWAR	CSE	P

For IIST

Chief Administrative Officer

IQAC



Principal

Indore Institute of Science and Technology, Indore

Saturday, December 21, 2024



Faag Utsav Attendance Sheet Record-3

INDORE INSTITUTE OF SCIENCE & TECHNOLOGY		
NAME OF ACTIVITY:		
S.No	Name	Branch
1	AADH SINGHAI	IT
2	AARVA RAGHU VANSHE	IT
3	ADITHYAN PANDIY	IT
4	ADITYA SHINDE	IT
5	ADITYA THATHI	IT
6	AMAN KULWA	IT
7	AMISH PAIWAL	IT
8	ANAND PANDIY	IT
9	ANKUSH MAHAJAN	IT
10	ANKUSH SARDIYA	IT
11	ANSHIKA	IT
12	ANSHIKA RATHORE	IT
13	ANUJ UPRETI	IT
14	ANUSHKA MAHAJAN	IT
15	ARUN MEENA	IT
16	ASHISH PRAJAPATI	IT
17	ASHISH SINGH	IT
18	ATUL VISHWAKARMA	IT
19	AYUSHI SHARMA	IT
20	BHAVESH GEHLOT	IT
21	BUDDHISTH BAIRAGI	IT
22	DAKSH NIMJE	IT
23	DEVENDRA BUWADE	IT
24	DHEERAJ PATEL	IT
25	DHEERAJ SINGH BAGHEL	IT
26	DIVYANSH SOMKUWAR	IT
27	HARSH TIWARI	IT
28	HARSHITA SONI	IT
29	HIMANSHI SINGH	IT
30	HIMANSHU SHARMA	IT
31	HONEY CHILHATE	IT
32	HRIDAY APTE	IT
33	HRISHIKA MALVIYA	IT
34	JAY MUKATI	IT
35	JAYA PATEL	IT
36	JIYA BAROD	IT
37	KAMLESH BAGDAWAT	IT
38	KHUSHBOO WALWANI	IT

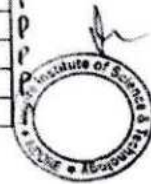

[Signature]
For IIST/ IIP/ IIMR

Chief Administrative Officer

[Signature]
IQAC



[Signature]
Principal

Indore Institute of Science
and Technology, Indore

Saturday, December 21, 2024



Faag Utsav Attendance Sheet Record-4

39	KOTI BHUPENDRA RAHENDRA	IT	P
40	KRATIK BHENDRA MAIVYA	IT	P
41	KRISH KUMAR UKANDAY	IT	P
42	KUNJAL VYAS	IT	P
43	KUSHAL SINGH DANGI	IT	P
44	LAKSHYA VISHWAKARMA	IT	P
45	LOKESH PAL	IT	P
46	MADHUR KARDAM	IT	P
47	MAYANK CHHALOTRE	IT	P
48	MAYANK MALAWANT	IT	P
49	NEERAJ TIKARE	IT	P
50	NIKHIL NIGAM	IT	P
51	NIKHIL YADAV	IT	P
52	PALAK SHUKLA	IT	P
53	PIYUSH PATIDAR	IT	P
54	PRATYUSH KUMAR	IT	P
55	PRINCE CHOUHAN	IT	P
56	PRINCESINGH THAKUR	IT	P
57	RIYA MAITY	IT	P
58	RIZWAN KHAN	IT	P
59	SATYAM PATEL	IT	P
60	SAURABH MEENA	IT	P
61	SHEETAL KHEDIA	IT	P
62	SHIVANAND CHOURE	IT	P
63	SHREEYA TIWARI	IT	P
64	SHYAM MANDLOI	IT	P
65	SUMIT PATEL	IT	P
66	SUVESH MUKATI	IT	P
67	SWARNIM OMRE	IT	P
68	TANVI KHANDELWAL	IT	P
69	TEJAS KISHOR CHOUDHARY	IT	P
70	TISHA SAHU	IT	P
71	VAIBHAV RUDRAWAL	IT	P
72	VEDIKA PAL	IT	P
73	VEER JAIN	IT	P
74	VIJAY PATEL	IT	P
75	VISHAL RATHORE	IT	P
76	YASH PAWAR	IT	P
77	YASH TOLANI	IT	P
78	YASH YOGI	IT	P
79	MINISHA SOLANKI	IT	P

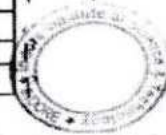

[Signature]
FOR IIST/ IIP/ IIMR
Chief Administrative Officer

[Signature]
IQAC



[Signature]
Principal

[Signature]
Principal
Indore Institute of Science
Saturday, December 21, 2024



Faag Utsav Attendance Sheet Record-5

INDORE INSTITUTE OF SCIENCE & TECHNOLOGY
NAME OF ACTIVITY:

S.No	Name	Branch	Signature
1	VARADHIVAJAN	AIML	P
2	ADARSH EDWARI	AIML	P
3	ADRIJIT JAIN	AIML	P
4	ADITYA CHOUDHARY	AIML	P
5	ADITYA SINGH RAJPUT	AIML	P
6	AKSHAT TRIVEDI	AIML	P
7	AKSHUPATHAR	AIML	P
8	ANSHIKA PUNASE	AIML	P
9	ANU SINGH PARIHAR	AIML	P
10	ARPI MISHRA	AIML	P
11	ARYAN THAKUR	AIML	P
12	ASHISH	AIML	P
13	ASHISH CHOCHAN	AIML	P
14	ATHARVA BARVE	AIML	P
15	AYUSHMAAN RATHORE	AIML	P
16	BHAVESH PRAJAPAT	AIML	P
17	BHUMIKA MALAKAR	AIML	P
18	CHANCHAL RATHORE	AIML	P
19	DARPAN NAGANPURIYA	AIML	P
20	DEEPANSHU GUPTA	AIML	P
21	DEEPANSHU MAHESHWARI	AIML	P
22	DEVERSHI TAWANI	AIML	P
23	DIKSHA AKVEAN	AIML	P
24	FATEMA	AIML	P
25	GOURAV SONWANE	AIML	P
26	HARDIK FADNAVIS	AIML	P
27	HARIOM KHETE	AIML	P
28	HARSHITA SONI	AIML	P
29	HITANSHI UPADHYAY	AIML	P
30	ISHANT RAJPUT	AIML	P
31	JAYESH MATHANKAR	AIML	P
32	KANAK RAWAT	AIML	P
33	KAVYA KHANTWAL	AIML	P
34	KESHAV CHIKHALIKAR	AIML	P
35	KRATIKA KACHOLE	AIML	P
36	KRISHNA KAVISHWAR	AIML	P
37	KULDEEP SONI	AIML	P
38	KUNAL PATIDAR	AIML	P

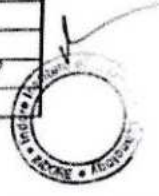

[Signature]
For IIST/ IIP/ IIMR
Chief Administrative Officer



[Signature]
Principal
Indore Institute of Science
and Technology, Indore
Saturday, December 21, 2024



Faag Utsav Attendance Sheet Record-6

39	TANVIYA KUSHWAH	AIML	P
40	MANANUJ SINGH RATHI	AIML	P
41	MANANUJ SINGH RATHI	AIML	P
42	MOHIT SEN	AIML	P
43	SMANVI KUSHWAH	AIML	P
44	MR. HANMAD RAHILI	AIML	P
45	MR. NIKAN LODHI	AIML	P
46	NANDINI SINGH	AIML	P
47	NAYAN ACHAK	AIML	P
48	NISHHA KANOBIYA	AIML	P
49	PALAK SHARMA	AIML	P
50	PIYUSHI PATEL	AIML	P
51	PRITHVIRAJ CHOUHAN	AIML	P
52	RAJ PATIDAR	AIML	P
53	RESHAM MISHRA	AIML	P
54	RISHI SINGH KUSHWAH	AIML	P
55	RIVA MISHRA	AIML	P
56	RUDRA DEWATWAL	AIML	P
57	SACHIN JAIN	AIML	P
58	SACHIN JALKHARE	AIML	P
59	SAMARTH NAGDE	AIML	P
60	SAMRADDHI PAWAR	AIML	P
61	SANIDHYA MAHESHWARI	AIML	P
62	SANYAM JAIN	AIML	P
63	SAPTAK GUPTA	AIML	P
64	SHAMIL MANSURI	AIML	P
65	SHARYARI SHAMBHARKAR	AIML	P
66	SHAURYA SHEKHAR SAHU	AIML	P
67	SHIVAM MAHAJAN	AIML	P
68	SHREYANSH GUPTA	AIML	P
69	SNEHA MALVIYA	AIML-FW	P
70	SUMIT SHARMA	AIML	P
71	SUMIT SINGH	AIML	P
72	SUSHIL CHAURASIA	AIML	P
73	TANISHQ BHAWAR	AIML	P
74	TEJASWA JAISWAL	AIML-FW	P
75	UDIT RATHOD	AIML	P
76	VINAY PANCHE	AIML	P
77	YASH JOSHI	AIML	P
78	YASH WANI	AIML	P
79			

For IISTY IIR/IMK
Chief Administrative Officer



Principal
Indore Institute of Science
and Technology, Indore

Saturday, December 21, 2024



Faag Utsav Attendance Sheet Record-7

INDORE INSTITUTE OF SCIENCE & TECHNOLOGY
NAME OF ACTIVITY:

S.No	Name	Year	Branch
1	SAMIR K SORANE	CSE	P
2	SARVAY NIGADVA	CSE	P
3	SARV NIGADVA	CSE	P
4	SARVANI DODTHARY	CSE	P
5	SARVANI SHUKLA	CSE	P
6	SANDEEP ROHTE	CSE	P
7	ABHAY SINGH	CSE	P
8	ABHISEK DOGNE	CSE	P
9	ADIT PITHWAN	CSE	P
10	ADIB RIZVI	CSE	P
11	ADITI	CSE	P
12	ADITYA GAWANDE	CSE	P
13	ADITYA MISHRA	CSE	P
14	ADITYA PAITHANKAR	CSE	P
15	AJAL SHEKH	CSE	P
16	AJAY DANGI	CSE	P
17	AJAY GOSWAMI	CSE	P
18	AJT GOND	CSE	P
19	AKASH CHOUDHARY	CSE	P
20	ALISH KHAN	CSE	P
21	AMAN	CSE	P
22	AMAN	CSE	P
23	AMAN KUMAR	CSE	P
24	AMAN VERMA	CSE	P
25	AMBICA SINGH RATHORE	CSE	P
26	AMIT KUMAR	CSE	P
27	AMITABH JAIN	CSE	P
28	AMITABH RANJAN	CSE	P
29	ANAIZA HASHMI	CSE	P
30	ANANYA PARE	CSE	P
31	ANKET SHUKLA	CSE	P
32	ANKET YADAV	CSE	P
33	ANKIT PRAJAPATI	CSE	P
34	ANKIT SHUKLA	CSE	P
35	ANKUR TIWARI	CSE	P
36	ANSHIKA SHARMA	CSE	P
37	ANSHUL MALVIYA	CSE	P
38	ANUGRAH SHAH	CSE	P

For IIST/ IIR/ IIMR
Chief Administrative Officer



Principal
Indore Institute of Science
& Technology, Indore
Saturday, December 21, 2024



Faag Utsav Attendance Sheet Record-8

39	ANUJ PANWAR	CSE	P
40	ANUJ PAHIL	CSE	
41	ANURAG PANDEY	CSE	P
42	ANURAG TASHAKAR	CSE	P
43	ANURAG VERMA	CSE	P
44	ARJUN SINGH BHATI	CSE	
45	ARUN	CSE	P
46	ATHARV RATHORE	CSE	P
47	ATHARV SHARMA	CSE	
48	ATUL PORWAL	CSE	
49	AVI MISHRA	CSE	P
50	AVINASH SAHU	CSE	P
51	AYUSH YADAV	CSE	P
52	BHAWESH DAWANDE	CSE	P
53	CHAITANYA KUMAR	CSE	P
54	CHANDRAPAL SINGH RAJPUT	CSE	
55	CHETAN	CSE	
56	DEEP TIROLE	CSE	P
57	DEEPAK PANDEY	CSE	P
58	DEEPIKA BAMNIYA	CSE	
59	DEVANSHU SHARMA	CSE	P
60	DHANRAJ	CSE	P
61	DHEERAJ CHOUDHARY	CSE	P
62	DHEERAJ INDRIYA	CSE	P
63	DHEERAJ KUSHWAHA	CSE	P
64	DIPESH SHAKYAWAR	CSE	P
65	DISHA GUPTA	CSE	P
66	FALGUNI KALBHUT	CSE	P
67	FEJAN RAJAWAT	CSE	P
68	GARVIT SHARMA	CSE	
69	GAURAV KUMAR	CSE	P
70	GAURI NEEMA	CSE	P
71	GAUTAM SHARMA	CSE	P
72	GEETIKA PATHAK	CSE	P
73	GORANK KANUGO	CSE	
74	HARDIK DERASHRI	CSE	P
75	HARIOM CHAUDHARY	CSE	P
76	HARIOM NAGAR	CSE	P
77	HARSH KALA	CSE	P
78	HARSH MAKWANA	CSE	P
79	HARSH PAWAR	CSE	P



FOR IIST/ HR/ IIMR

Chief Administrative Officer

IQAC



Page 81 of 150

Principal

Principal

Indore Institute of Science

Technology, Indore

Saturday, December 21, 2024



7. Indore Nodal Level Taekwondo (M/W) Team 2023-24

CHAMELI DEVI GROUP OF INSTITUTIONS
 • Approved by AICTE • Certified 2(f) by UGC • Recognized by DTE • Affiliated to RGPV and DAVV
 Gyan Vihar Khandwa Road, INDORE - 482 020 • Ph: 0731-4243600/5/9-4243670/79
 Fax: 0731-4243670 • E-mail: cdgi_indore@cdgi.edu.in • Website: www.cdgi.edu.in

www.cdgi.edu.in

To:
Director/Principal

Subject: For Indore Nodal Level Taekwondo (M/W) Team 2023-24

This is to inform you that Indore Nodal Taekwondo (M/W) Tournament was organized by CDGI college & Indore Nodal Taekwondo Team were selected, Indore Nodal Taekwondo (M/W) team has taken part in State Level Tournament on 25/11/23 to 26/11/2023 at Krishna college, Bhopal

S.No	Name of Player's/Official	Name of Institute
1	Rajveer gotam	SGSITS
2	Deepak panwar	BAI
3	Naman Sharma	IPS
4	Suyog jagdala	SGSITS
5	Bhavesh zerbade	IIST
6	Divyraj singh	MALWA
7	Tushar kala	CDGI
8	Nakul samerliya	CDGI
9	Aastha sisodiya	PRESTIGE
10	Arpita kushwah	SGSITS
11	Divyanshi pal	CDGI
12	Arohi joshi	PRESTIGE
13	Lakhita mukati	ACROP
14	Nehal mishra	AC RLP
15	Mr. Jamil khan	COACH

DA, TA and fare to the Coach/Manager will be provided by their respective institute as per the following rules.

- 1) T.A. D.A. Rs 500/- per player/official per day and to fro Bus/Train/Taxi fare
- 2) Every player should be provided Rs 400/- for sports uniform.
- 3) Students selected in state and university team of RGPV should be provided with regular attendance for that period.

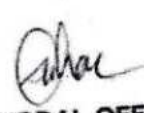
NODAL OFFICER
INDORE NODAL SPORTS CENTER
CHAMELI DEVI GROUP OF INSTITUTIONS

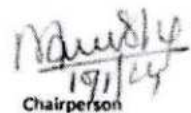
Chairperson
Indore Nodal Sports Center

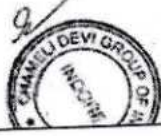

For IIST/IPP/IMR

Chief Administrative Officer

IQAC

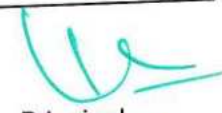

Principal
Indore Institute of Science
and Technology, Indore

Saturday, December 21, 2024



A. Indore Nodal Level Kabaddi (M/W) Team 2023-24 Dated- 02 Jan 2024

CHAMELI DEVI GROUP OF INSTITUTIONS

• Approved by AICTE • Certified 2(f) by UGC • Recognized by DTE • Affiliated to RGPV and DAVV

Gram-Utrikheda, Khandwa Road, INDORE - 452 070 • Ph : 0731-4243600/5/9-4243626/29
Fax : 0731-4243620 • E-mail : cdgi_indore@cdgi.edu.in • Website : www.cdgi.edu.in



To,
Director/Principal

Date 02/01/24

Subject: For Indore Nodal Level Kabaddi (M/W) Team 2023-24

This is to inform you that Indore Nodal Kabaddi (M/W) Tournament was organized by CDGI Collage & Indore Nodal Kabaddi I Team were selected. Indore Nodal Kabaddi (M/W) team has Taken part in State Level Tournament on 28/10/2023 to 29/10/2023 at CDGI, INDORE

S.No	Name of Player's/Official	Name of Institute
1	Aakash verma	LNCT
2	Sumit choudhari	LNCT
3	Aman patel	ACROP.
4	Vishal patel	CDGI
5	Kunal choudhary	TSGI
6	Vishal kher	LNCT
7	Ganesh shivede	TSGI
8	Yashpal singh	SVGI
9	Prashun kumar	LNCT
10	Abhay choudhary	LNCT
11	Mohit meena	CDGI
12	Sumit jat	ACROP.
13	Anuj panchal	HSI
14	Deepak yadav	SGSITS
15	Bairam choudhary	ACRO, Eng.
16	Mradul singh senger	ACRO, Eng.
17	Kumar waskal	JIT
18	Uttam mukati	JIT
19	Hasan dawar	JIT
	Mr. DheeraJ verma, Mr. Swapnil	COACH

DA, TA and fare to the Coach/Manager will be provided by their respective institute as per the following rules.

- 1) T.A. D.A. Rs 500/- per player/official per day and to fro Bus/Train/Taxi fare
- 2) Every player should be provided Rs 400/- for sports uniform.
- 3) Students selected in state and university team of RGPV should be provided with regular attendance for that period.

[Signature]
NODAL OFFICER
INDORE NODAL SPORTS CENTER
CHAMELI DEVI GROUP OF INSTITUTIONS

[Signature]
Chairperson
Indore Nodal Sports Center

For IIST/ IIP/ IIMR
[Signature]
Chief Administrative Officer



[Signature]
Principal
Indore Institute of Science
and Technology, Indore
Saturday, December 21, 2024



B. Indore Nodal Level Volleyball (M/W) Team 2023-24 Dated- 02 Jan 2024

CHAMELI DEVI GROUP OF INSTITUTIONS
 • Approved by AICTE • Certified 2(f) by UGC • Recognized by DTE • Affiliated to RGPV and DAVV

Gram Dmakherda, Khandwa Road, INDORE - 452 009 • Ph : 0731-4243629/5/9-4243626/29
 Fax : 0731-4243625 • E-mail : cdg_indore@cdg.edu.in • Website : www.cdg.edu.in

Director/Principal _____

Date - 02/1/24

Subject: For Indore Nodal Level volleyball (M/W) Team 2023-24

This is to inform you that Indore Nodal volleyball (M/W) competition was organized by IIST Indore & Indore Nodal volleyball Team were selected; Indore Nodal volleyball (M/W) team has Taken part in State Level competition at 01/11/2023 To 02/11/2023 at VNS Collage ,Bhopal

S.No	Name of Player's/Official	Name of Institute	S.No	Name of Player's/Official	Name of Institute
1	Jayesh patidar	CDGI	1	Pratishtha holkar	ACRO
2	Mohite shinde	CDGI	2	Tejaswini soni	SGSITS
3	Hariom sisodiya	AITR	3	Saniya patel	ACRO
4	Askash patel	SVCE	4	Aparna bhund	IITS
5	Pranav khar	IIST	5	Vidika rathore	IITS
6	Pradyumn shirsath	IIST	6	Anshika gupta	IPS
7	Prathviraj singh	AITR	7	Suhani biyani	SGSITS
8	Krishna Sharma	CDGI	8	Trisha sharma	ACRO
9	Ankush shrivastav	SDBC	9	Isha bairagi	LNCT
10	Arman yadav	SVCE	10	Milan badodiya	CDGI
11	Nikhil kumar	PIEMR	11	Manisha	CDGI
12	Nitin yadav	SVCE	12	Diksha golkar	MIT
13	Sumit singh choushan	AIPER	13		
14	Kunal yadav	SVCE	14	Mr. Mahendra sisodiya	COACH
15	Malay yadav	MIST	15		

DA, TA and fare to the Coach/Manager will be provided by their respective institute as per the following rules.

- 1) T.A. D.A. Rs 500/- per player/official per day and to fro Bus/Train/Taxi fare
- 2) Every player should be provided Rs 400/- for sports uniform.
- 3) Students selected in state and university team of RGPV should be provided with regular attendance for that period.

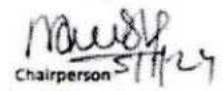
 Chairperson
 Indore Nodal Sports Center

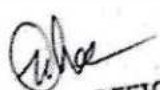
NODAL OFFICER
 INDORE NODAL SPORTS CENTER
 CHAMELI DEVI GROUP OF INSTITUTIONS

For IIST
Chief Administrative Officer



Principal
Indore Institute of Science
Indore
Saturday, December 21, 2024



IIST
Indore Institute of
Science & Technology

**Indore Institute of
Science & Technology**

Approved by AICTE, New Delhi, Affiliated to RGPV, Bhopal, Recognized by UGC under Section 2(f)
2023-2024

C. Indore Nodal Level Basketball (M/W) Team 2023-24 Dated- 02 Jan 2024

CHAMELI DEVI GROUP OF INSTITUTIONS

• Approved by AICTE. • Certified 2(f) by UGC • Recognized by DTE • Affiliated to RGPV and DAVV

Gram-Umakheda, Khambha Road, BHOPAL - 462 020 • Ph : 0731-4243606/5/9-4243676-7/9
Fax : 0731-4243620 • E-mail : cdg_indore@cdg.edu.in • Website : www.cdg.edu.in



To,
Director/Principal

Date 02/1/24

Subject: For Indore Nodal Level Basketball (M/W) Team 2023-24

This is to inform you that Indore Nodal Basketball (M/W) Tournament was organized by IIST & Indore Nodal Basketball Team were selected. Indore Nodal Basketball (M/W) team has Taken part in State Level Tournament on 26/11/2023 To 27/11/2023 at MIST ,Gwalior

S.No	Name of Player's/Official	Name of Institute
1	Aryan raj	SGSITS
2	Rakshit singh	SGSITS
3	Rahul singh	IIST
4	Shivansh pandey	IIST
5	Parivesh rimjha	ACROP.
6	Rohit chouban	ACROP.
7	Ridam mourya	ACROP.
8	Abhishek kumar	IPS
9	Prashant singh parmar	IPS
10	Vikas singh	SGSITS
11	Mohit khichi	SGSITS
12	Arnav sharma	IIST
	Dr. SUKHOEV BAMBORIYA	COACH

DA, TA and fare to the Coach/Manager will be provided by their respective institute as per the following rules.

- 1) T.A. D.A. Rs 500/- per player/official per day and to fro Bus/Train/Taxi fare
- 2) Every player should be provided Rs 400/- for sports uniform.
- 3) Students selected in state and university team of RGPV should be provided with regular attendance for that period.

Mushy
Chairperson
Indore Nodal Sports Center

[Signature]
NODAL OFFICER
INDORE NODAL SPORTS CENTER
CHAMELI DEVI GROUP OF INSTITUTIONS

[Signature]
For IIST/ IIR/ IIMR

Chief Administrative Officer

[Signature]
IQAC



[Signature]
Principal

Indore Institute of Science
& Technology, Indore

Saturday, December 21, 2024



D. Indore Nodal Level Football (M) Team 2023-24 Dated- 08 Jan 2024

CHAMELI DEVI GROUP OF INSTITUTIONS

• Approved by AICTE, • Certified 2(f) by UGC • Recognized by DTE • Affiliated to RGPV and DAV

Gram-Umakhela, Khandwa Road, INDORE - 452 020 • Ph. : 0731-4243600/5/9, 4243626-29
Fax : 0731-4243620 • E-mail : cdgi_indore@cdgi.edu.in • Website : www.cdgi.edu.in



To,
Director/Principal

RAJ 08/01/24

Subject: For Indore Nodal Level Football (M) Team 2023-24

This is to inform you that Indore Nodal football (M) Tournament was organized by IIP College & Indore Nodal Football Team were selected; Indore Nodal Football (M) team has Taken part in State Level Tournament on 1st Dec 2023 at IES University ,BHOPAL

S.No	Name of Player's/Official	Name of Institute
1	Rohan singh	IIST
2	Karmendra singh	CDGI
3	Dhruv Sharma	AITR
4	Subham kumar	SGSITS
5	Shekhar	AITR
6	Ashw in nair	AITR
7	Jayash sayema	ARBINDO
8	Ashutosh singh	AITR
9	Kushagra ahuja	SGSITS
10	Daruv verma	PIEMR
11	Vikas puri	BM
12	Prathmesh	IIST
13	Rachit tiwari	IPS
14	Rohan napit	IPS
15	Prashant	IPS
16	Prateek kushwah	IPS
17	Ronit chouhan	CDGI
	Mr.ALANKAR RAIKWAR	COACH

DA, TA and fare to the Coach/Manager will be provided by their respective institute as per the following rules.

- 1) T.A. D.A. Rs 500/- per player/official per day and to fro Bus/Train/Taxi fare
- 2) Every player should be provided Rs 400/- for sports uniform.
- 3) Students selected in state and university team of RGPV should be provided with regular

NODAL OFFICER
INDORE NODAL SPORTS CENTER
CHAMELI DEVI GROUP OF INSTITUTIONS

[Signature]



[Signature]
Chairperson
Indore Nodal Sports Center

[Signature]
For IIST/ IIP/ IIMR

Chief Administrative Officer



[Signature]
Principal
Indore Institute of Science
and Technology, Indore



E. Indore Nodal Level Cricket (M) Team 2023-24

CHAMELI DEVI GROUP OF INSTITUTIONS

• Approved by AICTE. • Certified 2(0) by UGC • Recognized by DTE • Affiliated to RGPV and DAVV

Gram-Umrakherda, Khondwa Road, INDORE - 452 020 • Ph : 0731-4243600/5/9, 4243626-29
Fax : 0731-4243620 • E-mail : cdgi_indore@cdgi.edu.in • Website : www.cdgi.edu.in



To,
Director/Principal

Subject: For Indore Nodal Level Cricket (M) Team 2023-24

This is to inform you that Indore Nodal Cricket (M) Tournament was organized by BM college & Indore Nodal Cricket Team were selected; Indore Nodal Cricket (M) team has Taken part in State Level Tournament on on 25/11/2023 to 27/11/2023 at Radharaman college, Bhopal

S.No	Name of Player's/Official	Name of Institute
1	Aniket patil	IPS
2	Dushant tanwar	CDGI
3	Anshuman Sharma	IPS
4	Dipendra gami	ACROP.
5	Aditya pal	BM
6	Aliyaz sheikh	SGSITS
7	Dhanendra singh	ACROP.
8	Vikas yadav	JIT
9	Anurag singh	ARBINDO
10	Hitesh mahekaliya	BANSAL
11	Vishal bangadiya	BM
12	Aashutosh chouhan	CDGI
13	Sarvgya singh panwar	ACROP
14	Sachin yadav	IIP
15	Avi tewari	SGSITS
16	Akshay das	ACROP
	Mr. Alankar Raikwas	COACH

DA, TA and fare to the Coach/Manager will be provided by their respective institute as per the following rules.

- 1) T.A. D.A. Rs 500/- per player/official per day and to fro Bus/Train/Taxi fare
- 2) Every player should be provided Rs 400/- for sports uniform.
- 3) Students selected in state and university team of RGPV should be provided with regular attendance for that period.

NODAL OFFICER
INDORE NODAL SPORTS CENTER
CHAMELI DEVI GROUP OF INSTITUTIONS



Chairperson
Indore Nodal Sports Center

For IIST/ IIP/ IIMR
Chief Administrative Officer



Principal
Indore Institute of Science
& Technology, Indore

Saturday, December 21, 2024



F. List of Participated Players in RGPV

Indore Institute of Science & Technology, Indore
Department of Sports
Session-2023-24

List of the Participated Players in RGPV Indore Nodal Inter District/State and RGPV West Zone Inter University Tournament 2023-24 in different games.

S No	Players Name	Branch/Year	Game	Particular
1	ANUJ PANCHAL	EC-3 rd Year	Kabaddi	He has participated in RGPV Inter District Kabaddi tournament and Secured 1st Position in Inter State Level tournament organized by CDGI Indore on 28 th & 29 th October-2023
2	Bhavesh Zerbade	EC-2 nd Year	Taekwondo	He has participated in RGPV Inter District Taekwondo Championship and Secured 2 nd Position in Inter State Level tournament organized by VITS College, Satna on 28 th & 29 th November-2023. Mr Bhavesh has also Selected for RGPV Inter University Games.
3	Dhairya Verma	CS-1 st Year	Swimming	Mr Verma & Mr Apte has participated in State Level Swimming Championship organized by Gyan Ganga Sagar College, Sugar on 26 th & 27 th December-2023
4	Hriday Apte	IT-1 st Year	Swimming	
5	Rizwan Khan	CS-1 st Year	Volleyball	Mr Shirsathe & Mr Khan has participated in Indore District Volleyball Tournament organized by VNS College, Bhopal on 1 st & 2 nd November-2023 and Indore Team Secured Runner Position.
6	Pradyumn Shirsathe	Civil-4 th Year	Volleyball	
7	Arpana Bhand	CS-2 nd Year	Volleyball	Indore Nodal Volleyball Girls Team Participated in State Level Tournament organized by VNS College, Bhopal on 1 st & 2 nd November-2023 and Secured Winner Position in State Level Championship 2023-24.
8	Vaidika Rathore	EC-3 rd Year	Volleyball	
9	Manisha	EC-3 rd Year	Volleyball	

FOR IIST/ IIR/ IIMR

Chief Administrative Officer

IQAC





Principal
Principal
Indore Institute of Science
& Technology, Indore
Saturday, December 21, 2024

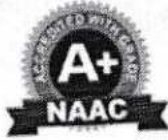

8. Permission to organize IIST Annual Sports Meet Approval Letter Dated- 5 March 2024

Indore Institute of Science & Technology, Indore

Department of Sports

Approval Letter

Date: - 5th March-2024

Subject: - Permission to organize IIST Annual Sports Meet-2023-24.

Respected Sir,

Indore Institute of Science & Technology (NAAC A+ Grade Institute) is organizing Annual Sports Meet (Intramural Competition) on 16th & 17th March-2024.

Basketball (B & G), Cricket (only Boys), Pickleball (B & G), Table Tennis & Chess (B & G) and Volleyball (B & G) will be held in this Annual Sports Meet. Sir, we request you to kindly permit to organize Annual Sports Meet (Intramural Competition) mentioned above dates.

Sukhdev
05/3/24
Dr. Sukhdev Bambariya
Dean, Sports
Physical Education & Sports
Indore Institute of Science
& Technology, INDORE



[Signature]
05/3/24
Dr. Keshav Patidar
Principal, IIST
Principal
Indore Institute of Science
and Technology, Indore

[Signature]
5/3
Shri Arun S Bhatnagar (IRS)
Hon'ble Group Advisor
SPARSH & SEWS Groups

[Signature]
For IIST/IIP/IIMR
Chief Administrative Officer



[Signature]
Principal
Principal
Indore Institute of Science
& Technology, Indore
Saturday, December 21, 2024



G. IIST Annual Sports Notice Dated- 5 March 2024

Indore Institute of Science & Technology, Indore

Department of Sports

IIST, Annual Sports Notice-2024

Date: - 5th March-2024

Indore Institute of Science & Technology are going to organize **Annual Sports Meet (Intramural Competition)** on 16th & 17th March-2024. Those students (Boys & Girls) who are interested to participate in annual sports meet, kindly submit your name to Departmental HOD before 13th March by 04:00 PM.

The games are: -

- Basketball (B & G)
- Cricket (only Boys)
- Chess (B & G) Individual Events
- Pickleball (B & G) Individual Event
- Table Tennis (B & G) Individual Events
- Volleyball (B & G)

Note: - Teams will consist of Branch Wise and One Player can participate in only 2 Games. Winner Teams will participate in Inter College Competition with IIP & IIMR College Winners.

Sukhdev
05/03/24
Dr. Sukhdev Bamboriya
Dean, Sports
Physical Education & Sp.
Indore Institute of Science
& Technology, INDORE



[Signature]
05/03/24
Dr. Keshav Patidar
Principal, IIST
Principal
Indore Institute of Science
and Technology, Indore

Copy to: - All HOD's (IIST)
Students Notice Board

[Signature]
For IIST/ IIP/ IIMR
Chief Administrative Officer



[Signature]
Principal
Principal
Indore Institute of Science
& Technology, Indore
Saturday, December 21, 2024



H. Remuneration Bill for Referees/Umpire Dated- 18 March 2024

INDORE INSTITUTE OF SCIENCE & TECHNOLOGY, INDORE

DEPARTMENT OF SPORTS

NO.

DATE: -18TH MARCH-2024

IIST Group of Educational Institutes has been organized Annual Sports & Inter College Tournament from 16th to 18th March-2024. Following Officials/Referees were part of this event.

Remuneration Bill for Referees/Umpire .

S. No	Name	Game	Days	Amount
01	Ajay Rawat	Volleyball	5	2,500/-
02	Sumit Mishra	Cricket	1	500/-
03	Amit Vyas	Cricket	1	500/-
04	Harsh Jain	Table Tennis	3	600/-
05	Sanskar Verma	Chess	3	600/-
06	Anuj Upreti	Basketball	3	600/-
07	Ritik Kumar	Cricket	5	2,000/-
08	Vijay Kalyane	Cricket	5	2,000/-
09	Shivansh Panday	Basketball	3	600/-
10	Tofiq Quraishi	Basketball	3	600/-
11	Yash Tolani	Cricket	3	600/-
12	Utkarsh Dubey	Volleyball	2	400/-
13	Aditya Sharma	Pickleball	2	400/-
14	Manisha	Volleyball	1	200/-
Twelve thousand one hundred only				12,100/-

Sukhdev
Dr. Sukhdev Bamboriya
Dean, Physical Education & Sports
Dean
Physical Education & Sports
Indore Institute of Science
& Technology, INDORE



[Signature]
Dr. Keshav Patidar
Principal, IIST
Principal
Indore Institute of Science
and Technology, Indore

[Signature]
For IIST/ IIV/ IMR

Chief Administrative Officer



[Signature]
Principal
Indore Institute of Science
& Technology, Indore

Saturday, December 21, 2024



I. Annual Sports Note Sheet Dated- 14 March 2024

Indore Institute of Science & Technology, Indore
Department of Sports
Note Sheet

Date: - 14th March-2024

Subject: - Items Require for Annual Sports Meet -2024.

Respected Sir,

IIST is organizing Annual Sports Meet on 16th & 17th March-2024 and organizing Inter College IIST/IIP/IIMR in our Premises. Following Item are required for smooth conduction of the event.

- Chairs 15 & Tables-5 nos
- Podium-1 & T- Table-1 nos
- Sound System on Cricket ground-1 nos
- Water Jar-3 nos
- Camera with Photo graphy-01 nos
- Bukey-02 nos
- Peon-2 Person
- Ambulance with Driver

Proposed Budget are: -

- Flex (8*6)-1 Rs. 500/-
- Officials Remuneration Rs: -7,000/-
- Certificate-190 nos Rs. 2000/-
- Medals-186 @ 40 nos Rs-8,000/-
- Overall championship Trophy-1 nos Rs. 500/-
- Tent 15*30 and 15*15 for 3 Days Rs: - 5,000/-

Total Amont: - 23,000/- Sir, kindly approve above amount for the Annual Sports.

Sukhdev
14/3/24
Dr. Sukhdev Bamboriya
Dean, Sports
Physical Education & Sports
Indore Institute of Science
& Technology, INDORE

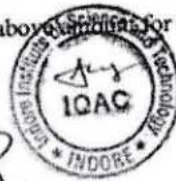

[Signature]
Dr. Keshav Patidar
Principal, IIST

[Signature]
Shri Arun S Bhatnagar (IRS)
Hon'ble Group Advisor
SPARSH & SEWS

Principal
Indore Institute of Science
and Technology, Indore

[Signature]
For IIST, IIP/ IIMR
Chief Administrative Officer



[Signature]
Principal
Principal
Indore Institute of Science
and Technology, Indore
Saturday, December 21, 2024



J. Duty List of Faculties/Staff

Indore Institute of Science & Technology, Indore

Department of Sports

IIST Annual Sports Meet on 16th & 17th March-2024

Date: - 11th March-2024

Duty List of the Faculties/Staff for IIST, Annual Sports on 16th & 17th & 18th March-2024.

S No	Name of Faculty	Department	Duty Place
1	Mr. Ishanya Joshi	Civil	Overall Coordinator
2	Dr Irfan Mansuri	Physics	Overall Coordinator
3	Dr Amit Jain	Physics	Cricket Ground
4	Mr. Shashank Ji	Civil	Table Tennis/Chess
5	Mr. Rohit Dwivedi	Hostel	Volleyball Court
6	Mr. Mahaveer Dangi	Civil	Cricket Ground
7	Mr. Akashdeep Gupta	ME	Pickleball
8	Mr. Nitin Chouhan	EC	Table Tennis/Chess
9	Mr. Anshul Jain	Mathematics	Basketball Court
10	Mr. Ashutosh Mehta	Sports	Pickleball

Sukhdev
14/3/24
Dr. Sukhdev Bamboriya
Dean, Sports
Physical Education & Sports
Indore Institute of Science
& Technology, INDORE



Keshav Patidar
14/3/24
Dr. Keshav Patidar
Principal, IIST

Principal
Indore Institute of Science
and Technology, Indore

Arun S Bhatnagar
Shri Arun S Bhatnagar (IRS)
Hon'ble Group Advisor
SPARSH & SEWS Groups

[Signature]
For IIST/ IIP/ IIMR
Chief Administrative Officer



[Signature]
Principal
Indore Institute of Science
& Technology, Indore

Saturday, December 21, 2024



K. Result List of the Winners & Runners Team Attached

Institute awarded Certificates to all the Winners & Runners Players with the presence of Hon'ble Group Advisor Sri Arun S Bhatnagar-IRS & Principal, IIST. During the Closing Ceremony All HOD and Faculty of different department were present.

Sukhdev
Dr. Sukhdev Bhandari
Dean, Physical Education & Sports
Indore Institute of Science
& Technology, INDORE

Keshav
Dr. Keshav Patidar
Principal, IIST
Indore Institute of Science
& Technology, Indore

Note: - Result List of the Winners & Runners Team Attached:

Game	Category	Winners	Runners
Basketball	Boys	CS- 1 st & 2 nd Year	AIML+IOT+DS
Basketball	Girls	AIML+IOT+DS	CS- 1 st & 2 nd Year
Cricket	Boys	IOT+DS	CS- 4 th Year
Chess	Boys	Harsh Agrawal (CS-2 nd Year)	Preet Gupta (ME-4 th Year)
Chess	Girls	Shubhi Tiwari (CS-1 st Year)	Ishika Agrawal (CS-1 st Year)
Table Tennis	Boys	Aman Kumar (EC-4 th Year)	Rudra Dewatwal (AIML-1 st Year)
Table Tennis	Girls	Aparna Bhand (AIML-3 rd Year)	Shreya Saxena (CS-1 st Year)
Volleyball	Boys	IT- 1 st & 2 nd Year	CS- 3 rd & 4 th Year
Volleyball	Girls	Information Technology	AIML+IOT+DS
Pickleball	Boys	Utkarsh Dubey (EC-3 rd Year)	Anuj Panchal (EC-3 rd Year)
Pickleball	Girls	Sarika Purohit (IT-4 th Year)	Kajal Panwar (AIML-2 nd Year)

Ishanya
Mr. Ishanya Joshi
Asst Prof Civil

Irfan
Dr Irfan Mansuri
Asst Prof Physics

Sukhdev
Dr. Sukhdev Bhandariya
Dean, Sports
Physical Education & Sports
Indore Institute of Science

Keshav
Dr. Keshav Patidar
Principal IIST
Principal
Indore Institute of Science



[Signature]
For IIST/ IIR/ IIMR

Chief Administrative Officer



[Signature]
Principal
Indore Institute of Science
& Technology, Indore

Saturday, December 21, 2024



Indore Institute of Science & Technology, (IIST) Indore has successfully organized Annual Sports Meet (Inter Branches) on 16th & 17th March-2024. Total 6 Games (Basketball, Cricket, Chess, Pickleball, Table Tennis & Volleyball) were included in this meet. All the matches were played Knock out Basis. The opening Ceremony Chief Guest was Hon'ble Group Advisor Sri Arun S Bhatnagar-IRS and Special Guest was Dr. Keshav Patidar Principal, IIST.

All the teams were consistent with Branch wise like, CS, IT, EC, ME, Civil, Chemical and AIML. The Result of the meet are attached here with Report.

For IIST/ IIP/ IIMR
Chief Administrative Officer



Principal
Principal
Indore Institute of Science
and Technology, Indore
Saturday, December 21, 2024



9. Event- Annual Sport Meet Dated- 16 to 17 March 2024

Indore Institute of Science & Technology

Department of Sports
Session-2023-24

IIST Annual Sports Report on 16th & 17th March-2024

Academic Year: 2023-2024

Name of Event: Annual Sports Meet (Inter Branches)

Date of Event: 16th & 17th March-2024

Event Coordinators: Mr. Ishanya Joshi 2. Dr Irfan Mansuri

Details of Participants:

S.	Name of Events	No. of Participants	Department
I	Annual Sports Meet - 2024 (Intramural- Inter Branches Competitions)	450	All Departments



[Signature]
For IIST/ IIP, IIMR
Chief Administrative Officer



[Signature]
Principal
Principal
Indore Institute of Science
and Technology, Indore
Saturday, December 21, 2024



Indore Institute of Science & Technology, Indore

Department of Sports

IIST, Sports Players of the Year 2023-24

Sr	Name	Playing Details
1	Mr. Utkarsh Dubey (EC-3rd Year) (FIRST POSITION)	<ul style="list-style-type: none"> • Mr. Utkarsh has Participated in Indian Open 2024 (International Pickleball Tournament) held in National Sports Club of India, Mumbai from 7th to 10th February-2024 and Secured Gold Medal in 19+ Intermediate Singles & Bronze Medal in 19+ Advance Singles. • Mr Utkarsh was Member of Khelo MP Youth Games as a Volunteer in Basketball, Table Tennis and Weightlifting Event held at Basketball Complex, Indore from 1st to 4th October-2023 Organized by Government of Madhya Pradesh. <p style="text-align: center;">He has also Participated in: -</p> <ul style="list-style-type: none"> • Tournament Name: -Raising Pickleball Season 1.2 • Tournament Date: - 24th & 25th February-2024 • Organized by: - Raising Tennis Academy, Dhar • Positions: - Gold Medal (Opens Doubles) & Bronze Medal (Opens Singles) • Tournament Name: - 7th State Pickleball Tournament • Tournament Date: - 13th & 14th August-2023 • Tournament Venue: - The Emerald Heights International School, Indore • Positions: - Silver Medal (Opens Singles) & Bronze Medal (Opens Doubles) • Tournament Name: - RGPV State Level Volleyball Tournament • Tournament Date: - 15th December-2021 • Organized by: - RIT, BSF Takenpur Gwalior • Positions: -Silver Medal (Team-Runner Up)

FoF IIST/ IIR/ IIMR
Chief Administrative Officer



Principal
Principal
Indore Institute of Science
and Technology, Indore
Saturday, December 21, 2024



2	<p>Mr. Bhavesh Zerbade (EC-2nd Year) (SECOND POSITION)</p>	<ul style="list-style-type: none"> • Mr. Bhavesh Zerbade has participated in RGPV, All India Inter University Taekwondo Tournament held at Shri Jagdish prasad Jhabarmal Tiberwala University, Jhunjhunu from 2nd to 5th November- 2023. • Mr. Bhavesh has participated in RGPV State Level Taekwondo Tournament held at Shri Rama Krishna College of Pharmacy, Karhi, Satna on 29th October-2023 & Secured First Position in 68 Kg Weight Category. • Mr. Bhavesh has participated in Indore Nodal Inter Collegiate Karate & Taekwondo Tournament held at Aurobindo Institute Indore on 15th & 16th November-23 and Secured Gold Medal in 70 Kg Weight Category.
3	<p>Ms. Sarika Purohit (IT-4th Year) (THIRD POSITION)</p>	<ul style="list-style-type: none"> • Ms. Sarika Purohit has Appeared in Nationals Skating Selection Trials from 5th-8th November 2023 at Gwalior above 17 Seniors' Girl's category. Qualified for 61st Nationals Roller Skating Championship 2023 with Bronze Medal. • Ms. Sarika has Represented IIST/MP in 61st Nationals Roller Skating Championship-23 organized by Koller Skating Federation of India from 11th-25th December-2023 • Ms. Sarika has Participated in Rising Pickleball Season 1.2 organized by Rising Tennis Academy, Dhar on 24th & 25th February-2024 and She has Secured Bronze Medal in Open Doubles Category. • Ms. Sarika Purohit was Member of Khelo MP Youth Games as a Volunteer in Basketball & Table Tennis Event held at Basketball Complex, Indore from 1st to 4th october-2023 Organized by Government of MP. • She was Member of Referee team in 2nd National Pickleball Tournament from 7th to 9th October-2022 organized by MP Pickleball Association in association with IIST College, Indore.

For IIST/ IIP/ IIMR

Chief Administrative Officer





Principal
Principal
Indore Institute of Science
and Technology, Indore

Saturday, December 21, 2024





She has also Participated In :-		
4	Kamal Parihar ME-2 nd Year (FIRST POSITION)	<ul style="list-style-type: none">• Tournament Name: - Open Roller-Skating District Championship• Tournament Date: - 9th & 10th November-2021• Organized by: - The Emerald heights international School.• Positions: -Gold Medal in 500 mts Rink Race, 1000 mts Rink Race & 1 km Road Race• Mr Kamal Parihar has participated in All India Drop Roball Inter University Tournament held at Sandeep University, Nasik, Maharashtra from 17th to 20th May-2024.• RGPV University won the West Zone Drop Roball tournament and Mr Kamal has secured First Position in Individual Category.
5	Harshit Kadam ME-3 rd Year	<ul style="list-style-type: none">• Mr Kadam has participated in All India Drop Roball Inter University Tournament held at Sandeep University, Nasik, Maharashtra from 17th to 20th May-2024. RGPV University Won the West Zone Drop Roball tournament 2023-24.

Dr. Sukhdev Bamboriya
Dean, Physical Education & Sports

Dr. Keshav Patidar
Principal, IIST

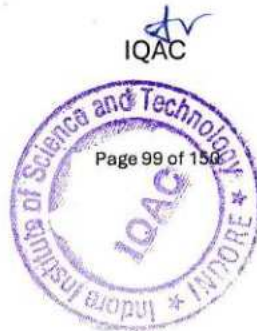
For IIST/ IIP/ IIMR
Chief Administrative Officer



Principal
Principal
Indore Institute of Science
and Technology, Indore
Saturday, December 21, 2024



L. IIST Annual Sports Meet Cricket (Boys) Fixture

Indore Institute of Science & Technology, Indore

Department of Sports

IIST Annual Sports Meet on 16th & 17th March-2024

Session- 2023-24

Cricket (Boys) Fixture

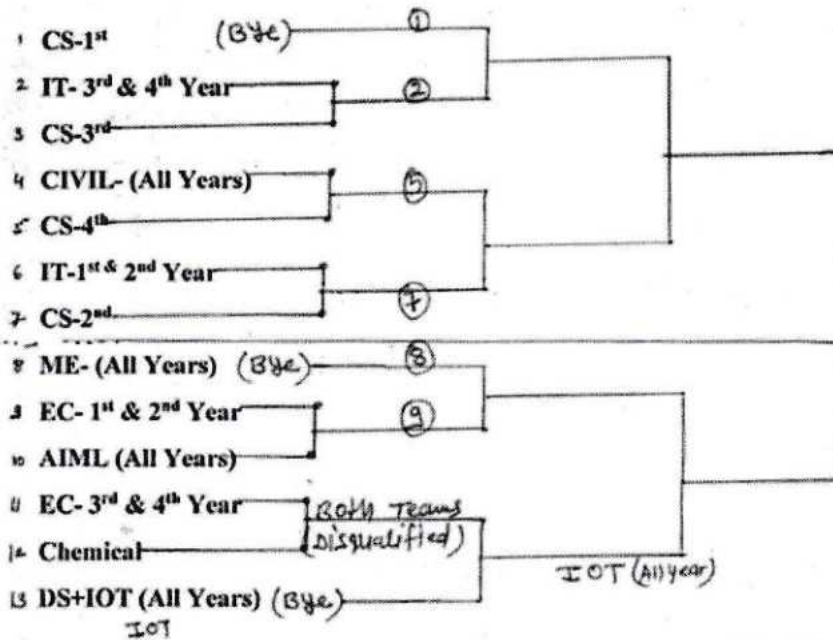

Note: - EC- 3rd & 4th year & chemical Teams are Disqualified from cricket event.

- Sports Shoes and Lower T-Shirts are Compulsory to all the participants.
- All the teams will report on time, kindly maintain the discipline on Sports Ground.
- All the matches Will Played 6 overs.
- Team will Consist of 15 Players (11 Playing & 4 Extra).
- Each Players 2 over only and 1st over will be Power Play.
- All the rules will applicable except LBW.

Subhakar
7/3/24
(Dear Sports)

Subhakar

Principal

Principal

Indore Institute of Science and Technology, Indore
Saturday, December 21, 2024

[Signature]
For IIST/ IIR/ IIMR
Chief Administrative Officer

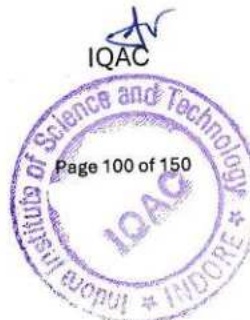



M. IIST Annual Sports Meet Basketball (Boys) Fixture

Indore Institute of Science & Technology, Indore

Department of Sports

IIST Annual Sports Meet on 16th & 17th March-2024

Session- 2023-24

Basketball (Boys) Fixture

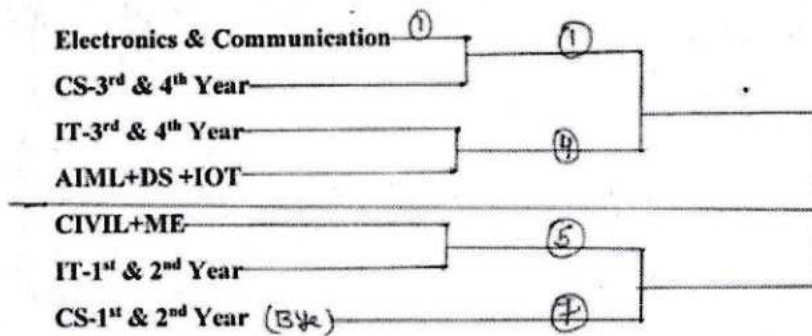

Note: -

- Sports Shoes are Compulsory to all the participants.
- All the teams will report on time.
- All the players will come in proper sports uniform.
- Please maintain the discipline on Sports Ground.
- Match time will 15 Minutes each Half in be Running time.

Sukhdev
Dean

Physical Education & Sports
Indore Institute of Science
& Technology, INDORE

[Signature]
IQAC

[Signature]
Principal

[Signature]
For IIST/ IP/ IIMR
Chief Administrative Officer



Principal
Indore Institute of Science
& Technology, Indore
Saturday, December 21, 2024



N. IIST Annual Sports Meet Volleyball (Boys) Fixture

Indore Institute of Science & Technology, Indore
Department of Sports
IIST Annual Sports Meet on 16th & 17th March-2024
Session- 2023-24

Volleyball (Boys) Fixture

CS-3 rd & 4 th Year	①	
CIVIL+ME	②	
AIML+DS +IOT	③	
Electronics & Communication	④	
CS-1 st & 2 nd Year	⑤	
IT-3 rd & 4 th Year	⑥	
IT-1 st & 2 nd Year (B.Ye.)	⑦	

Note: -

- Sports Shoes are Compulsory to all the participants.
- All the teams will report on time.
- All the players will come in proper sports uniform.
- Please maintain the discipline on Sports Ground.
- Match will Play for 25 Points (only 1 Set) and Final Match Will Played Best of 3 Sets of 15-15-15 Points.

Sudhakar Deen
Physical Education & Sports
Indore Institute of Science
& Technology, INDORE

[Signature]
For IIST/ IIP/ IIMR
Chief Administrative Officer



[Signature]
Principal

Indore Institute of Science
and Technology, Indore

Saturday, December 21, 2024



O. IIST Annual Sports Meet Basketball (Girls) Fixture

Indore Institute of Science & Technology, Indore
Department of Sports
IIST Annual Sports Meet on 16th & 17th March-2024
Session- 2023-24

Basketball (Girls) Fixture

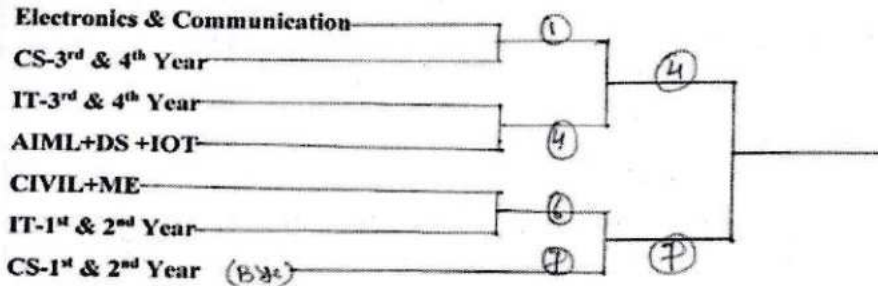

Note: -

- Sports Shoes and sports uniform are Compulsory to all the participants.
- All the teams will report on time. Please maintain the discipline on Sports Ground.
- Match time will 10 Minutes each Half in be Running time.

Sushil
Dean
Physical Education & Sports
Indore Institute of Science
& Technology, INDORE

SV
IQAC

[Signature]
Principal

[Signature]
For IIST/ IIP/ IIMR
Chief Administrative Officer



Principal
Indore Institute of Science
& Technology, Indore
Saturday, December 21, 2024



P. IIST Annual Sports Meet Volleyball (Girls) Fixture

Indore Institute of Science & Technology, Indore

Department of Sports

IIST Annual Sports Meet on 16th & 17th March-2024

Session- 2023-24

Volleyball (Girls) Fixture

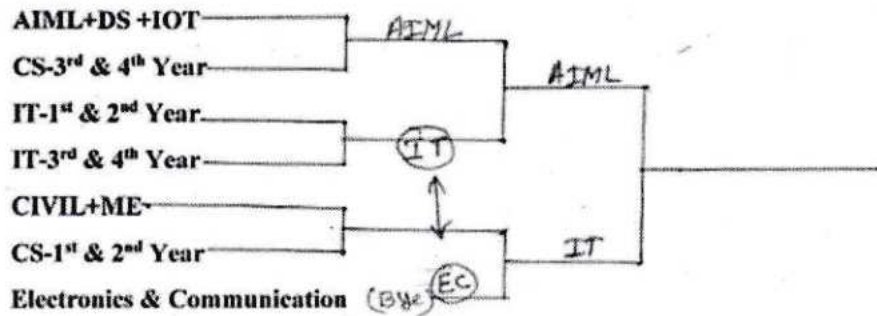

Note: -

- Sports Shoes and sports uniform are Compulsory to all the participants.
- All the teams will report on time. Please maintain the discipline on Sports Ground.
- Match will Play for 25 Points (only 1 Set) and Final Match Will Played Best of 3 Sets of 15-15-15 Points.

Sankhale
Dean

Physical Education & Sports
Indore Institute of Science
& Technology, INDORE

IQAC
IQAC

Principal
Principal

Principal

Indore Institute of Science

and Technology, Indore
Saturday, December 21, 2024

Chief Administrative Officer
For IIST/ IIP/ IIMR
Chief Administrative Officer





Q. IIST Annual Sports Meet Cricket (Boys Team)

Cricket (Boys Teams)

CIVIL- (All Years)

CS-4th

AIML (All Years)

DS+IOT (All Years)

CS-1st

IT- 3rd & 4th Year

CS-3rd

CS-2nd

IT-1st & 2nd Year

ME- (All Years)

EC- 1st & 2nd Year

EC- 3rd & 4th Year

Note: -

- **Dear Students, please submit your team List before 15th March by 3 PM at Departmental HOD/Class Coordinator.**
- **Chess, Pickleball & Table Tennis Events will be Individuals. (Direct Entry Basis)**

For IIST/ IIP/ IIMR

Chief Administrative Officer

IQAC

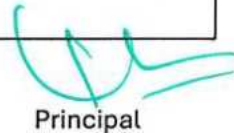

Principal

Principal
Indore Institute of Science
and Technology, Indore
Saturday, December 21, 2024



IIST
Indore Institute of
Science & Technology

**Indore Institute of
Science & Technology**

Approved by AICTE, New Delhi, Affiliated to RGPV, Bhopal, Recognized by UGC under Section 2(f)
2023-2024

R. IIST Annual Sports Meet Basketball(Boys & Girls Team)

**Indore Institute of Science & Technology, Indore
Department of Sports**

(IIST Annual Sports Meet on 16th & 17th March-2024)

Basketball (Boys & Girls Teams)

**CS-1st & 2nd Year
CS-3rd & 4th Year
Electronics & Communication
IT-3rd & 4th Year
AIML+DS +IOT
CIVIL+ME
IT-1st & 2nd Year**

Volleyball (Boys & Girls Teams)

**AIML+DS +IOT
IT-1st & 2nd Year
CS-1st & 2nd Year
CIVIL+ME
IT-3rd & 4th Year
Electronics & Communication
CS-3rd & 4th Year**

IQAC

Principal

For IIST/ IIP/ IIMR

Chief Administrative Officer



Principal
Indore Institute of Science
and Technology, Indore
Saturday, December 21, 2024



S. IIST Annual Sports Meet Volleyball Score Sheet

IIST, Annual Sports Meet on 16th & 17th March-2023-24
Volleyball Score Sheet Date.....

Match: (A) _____ V/S (B) _____

S. No.	Players Name	S. No.	Players Name
1	_____	1	_____
2	_____	2	_____
3	_____	3	_____
4	_____	4	_____
5	_____	5	_____
6	_____	6	_____
7	_____	7	_____
8	_____	8	_____
9	_____	9	_____
10	_____	10	_____
11	_____	11	_____
12	_____	12	_____

1 2 3 4 5 6 7 8 9 10 11 12 13 14 15	SET 1	1 2 3 4 5 6 7 8 9 10 11 12 13 14 15	16 17 18 19 20 21 22 23 24 25
16 17 18 19 20 21 22 23 24 25	SET 2	1 2 3 4 5 6 7 8 9 10 11 12 13 14 15	16 17 18 19 20 21 22 23 24 25
1 2 3 4 5 6 7 8 9 10 11 12 13 14 15	SET 3	1 2 3 4 5 6 7 8 9 10 11 12 13 14 15	16 17 18 19 20 21 22 23 24 25

Result: _____ Won by _____

Referee:-1.....Referee:-2..... Scorer:-.....

For IIST/ IIP/ IIMR
Chief Administrative Officer



Principal
Indore Institute of Science
& Technology, Indore
Saturday, December 21, 2024

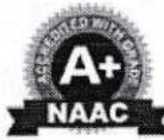

T. IIST Annual Sports Meet Table Tennis Score Sheet

IIST, Annual Sports Meet on 16th & 17th March-2023-24

Table Tennis Score Sheet
Individual

1. Player Name, Branch & Year _____
2. Player Name, Branch & Year _____

Singles

I. _____ I. _____

Match won by _____

Referee Signature

IIST, Annual Sports Meet on 16th & 17th March-2023-24

Table Tennis Score Sheet
Individual

1. Player Name, Branch & Year _____
2. Player Name, Branch & Year _____

Singles

I. _____ I. _____

Match won by _____

Referee Signature

For IIST/ IP/ IIMR
Chief Administrative Officer

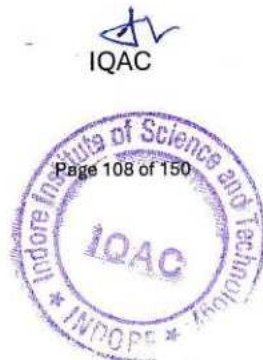

Principal
Principal
Indore Institute of Science
Technology, Indore
Saturday, December 21, 2024



Indore Institute of Science & Technology

Approved by AICTE, New Delhi, Affiliated to RGPV, Bhopal, Recognized by UGC under Section 2(f)
2023-2024

V. IIST Annual Sports Meet Pickleball Score Sheet

IIST, Annual Sports Meet on 16th & 17th March-2023-24

Pickleball Score Sheet Date.....

Players Name with Branch Year V/S Players Name with Branch Year

1 _____ V/S 1 _____

1 2 3 4 5 6 7 8 9 10 11 12 13 14 15	SET 1	1 2 3 4 5 6 7 8 9 10 11 12 13 14 15
1 2 3 4 5 6 7 8 9 10 11 12 13 14 15	SET 2	1 2 3 4 5 6 7 8 9 10 11 12 13 14 15
1 2 3 4 5 6 7 8 9 10 11 12 13 14 15	SET 3	1 2 3 4 5 6 7 8 9 10 11 12 13 14 15

Result: Won By:

Scorer Signature with Date: -

IIST, Annual Sports Meet on 16th & 17th March-2023-24

Pickleball Score Sheet Date.....

Players Name with Branch Year V/S Players Name with Branch Year

1 _____ V/S 1 _____

1 2 3 4 5 6 7 8 9 10 11 12 13 14 15	SET 1	1 2 3 4 5 6 7 8 9 10 11 12 13 14 15
1 2 3 4 5 6 7 8 9 10 11 12 13 14 15	SET 2	1 2 3 4 5 6 7 8 9 10 11 12 13 14 15
1 2 3 4 5 6 7 8 9 10 11 12 13 14 15	SET 3	1 2 3 4 5 6 7 8 9 10 11 12 13 14 15

Result: Won By:

Scorer Signature with Date: -

For IIST/ IIP/ IIMR

Chief Administrative Officer



Principal
Principal
Indore Institute of Science
Indore
Saturday, December 21, 2024



Student Name	Enrolment Number	Branch/Section	Game
Dr.sukhdev	Dhhk355	A-1(CS)	Basketball
Aggr	Hshhdd	A-1(CS)	Basketball;3Cc Cricket (only Boys)
Tejas Choudhary	0818T231069	A-4(IT)	3Cc Table Tennis (B & G) Individual Events;3Cc Volleyball (B & G)
Dhairya varma	0818CD231016	B-2(DS)	3Cc Volleyball (B & G)
Ayush yadav	0818CS231051	A-1(CS)	Basketball;3Cc Volleyball (B & G)
Jayesh kashyap	0818CD231027	B-2(DS)	3Cc Cricket (only Boys);3Cc Chess (B & G) Individual Events
Hriday Apte	0818T231031	A-4(IT)	Basketball
Yash Joshi	0818CL231077	B-1(AIPL)	3Cc Cricket (only Boys);3Cc Volleyball (B & G)
Arijun Singh Bhatti	0818CS231044	A-1(CS)	3Cc Volleyball (B & G)
Arsh Ukande	0818T231040	A-4(IT)	3Cc Pickleball (B & G) Individual Event;3Cc Volleyball (B & G)
Raja Sharma	0818CS231148	A-2(CS)	3Cc Cricket (only Boys)
Neeraj Tikare	0818UT231049	A-4(IT)	3Cc Cricket (only Boys)
Mayank Yadav	0818IS231021	B-4(IOT)	3Cc Cricket (only Boys)
Nikunj bisen	0818EC231027	B-3(EC)	Basketball;3Cc Cricket (only Boys)
Pradeep Dodwal	0818cs231135	A-2(CS)	3Cc Cricket (only Boys)
Nikunj bisen	0818EC231037	B-3(EC)	Basketball;3Cc Cricket (only Boys)
Rumy Kumar snah	0818cs231198	A-3(CS)	3Cc Cricket (only Boys);3Cc Volleyball (B & G)
Harion choudhary	0818cs231075	A-1(CS)	3Cc Cricket (only Boys)
Harion choudhary	0181CS231075	A-1(CS)	3Cc Cricket (only Boys)
Insalat Malviya	0818CS231037	A-1(CS)	3Cc Pickleball (B & G) Individual Event;3Cc Table Tennis (B & G) Individual Events
Amitesh bagdawat		36 A-4(IT)	3Cc Cricket (only Boys);3Cc Pickleball (B & G) Individual Event
UJWAL TRIVARI	0818ME231020	B-4(ME)	3Cc Cricket (only Boys);3Cc Volleyball (B & G)
Karsh Pawar	0818CS231079	A-1(CS)	3Cc Cricket (only Boys);3Cc Volleyball (B & G)
esh parashar	0818CS122331	A-3(CS)	3Cc Cricket (only Boys)
Jourav Parmar	0818CD231021	B-2(DS)	3Cc Cricket (only Boys)
artik Patidar	0818CS231096	A-2(CS)	3Cc Pickleball (B & G) Individual Event
Jarabhi moena	0818T231060	A-4(IT)	3Cc Chess (B & G) Individual Events
Karshit Hirekumbhar	0818EC231018	B-3(EC)	3Cc Chess (B & G) Individual Events;3Cc Volleyball (B & G)
nikit Shukta	0818CS231034	A-1(CS)	3Cc Cricket (only Boys);3Cc Volleyball (B & G)
ash malviya	0818CS231227	A-3(CS)	3Cc Cricket (only Boys);3Cc Table Tennis (B & G) Individual Events

IQAC

Principal

Principal

Indore Institute of Science and Technology
Sunday, December 21, 2024

For IIST/ IIP/ IIMR

Chief Administrative Officer





Logical Operators

There are following logical operators supported by C++ language.

Assume variable A holds 1 and variable B holds 0, then -

Operator	Description	Example
&&	Called Logical AND operator. If both the operands are non-zero, then condition becomes true.	(A && B) is false.
	Called Logical OR Operator. If any of the two operands is non-zero, then condition becomes true.	(A B) is true.
!	Called Logical NOT Operator. Use to reverses the logical state of its operand. If a condition is true, then Logical NOT operator will make false.	!(A && B) is true.

Bitwise Operators

Bitwise operator works on bits and perform bit-by-bit operation. The truth tables for &, |, and ^ are as follows -

p	q	p & q	p q	p ^ q
0	0	0	0	0
0	1	0	1	1
1	1	1	1	0
1	0	0	1	1

Assume if A = 60: and B = 13: now in binary format they will be as follows -

A = 0011 1100

B = 0000 1101

A & B = 0000 1100

A | B = 0011 1101

A ^ B = 0011 0001

~A = 1100 0011

For IIST/ IIP/ IIMR

Chief Administrative Officer



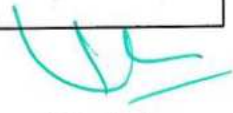

Principal

Principal

Indore Institute of Science

and Technology, Saturday, December 21, 2024



Surav sorwane	0818CI231025	B-1(AIML)	♣♣ Cricket (only Boys)
aj Yadav	0818CD231065	B-2(DS)	♣♣ Cricket (only Boys);♣♣ Table Tennis (B & G) Individual Events
spendra kote	0818I7231038	A-4(IT)	♣♣ Cricket (only Boys);♣♣ Table Tennis (B & G) Individual Events
RVIT Sharma	0818CS231068	A-1(CS)	♣♣ Cricket (only Boys)
nan Bhandari	0818CS231158	A-3(CS)	♣♣ Cricket (only Boys);♣♣ Pickleball (B & G) Individual Event
nvendra	0818CS231163	A-3(CS)	♣♣ Cricket (only Boys);♣♣ Pickleball (B & G) Individual Event
njan sisodiya	0818IS231011	B-4(IOT)	♣♣ Cricket (only Boys);♣♣ Volleyball (B & G)
um Soni	0818IS231024	B-4(IOT)	♣♣ Volleyball (B & G)
askar jain	0818ME231005	B-4(ME)	♣♣ Cricket (only Boys);♣♣ Volleyball (B & G)
an patil	0818CS231045	A-1(CS)	♣♣ Cricket (only Boys)
dit tripathi	0818ME231013	B-4(ME)	♣♣ Cricket (only Boys)
nesh Kumar Dwivedi	0818IS231029	B-4(IOT)	Basketball;♣♣ Cricket (only Boys)
rdik Derashn erashri	0818CS231074	A-1(CS)	♣♣ Cricket (only Boys);♣♣ Table Tennis (B & G) Individual Events
rsh kala	0818CS231077	A-1(CS)	♣♣ Cricket (only Boys);♣♣ Volleyball (B & G)
sh Das	0818CD1030	B-2(DS)	♣♣ Volleyball (B & G)
mnivas Dang	0818CS231150	A-2(CS)	Basketball;♣♣ Chess (B & G) Individual Events
riya Mishra	0818CS231013	A-1(CS)	♣♣ Cricket (only Boys);♣♣ Table Tennis (B & G) Individual Events
ngesh patel	0818CD231018	B-2(DS)	♣♣ Table Tennis (B & G) Individual Events;♣♣ Volleyball (B & G)
dra Dewankat	0818CI231056	B-1(AIML)	♣♣ Table Tennis (B & G) Individual Events
hanv Rawat	0818EC231008	B-3(EC)	♣♣ Table Tennis (B & G) Individual Events
hanv Rawat	0818EC231008	B-3(EC)	♣♣ Table Tennis (B & G) Individual Events
surav Kumar	0818CS231069	A-1(CS)	♣♣ Cricket (only Boys)
khil Raj	0818CD231042	B-2(DS)	♣♣ Cricket (only Boys)
pyanshi karna	0818US231010	B-4(IOT)	Basketball
ideep Gurjar	0818CD231032	B-2(DS)	♣♣ Cricket (only Boys)
ket sahu	0818CD231061	B-2(DS)	♣♣ Volleyball (B & G)
ya Mishra	0818231055	B-1(AIML)	♣♣ Chess (B & G) Individual Events
eyank malawant	0818I7231047	A-4(IT)	Basketball;♣♣ Cricket (only Boys);♣♣ Pickleball (B & G) Individual Event;♣♣ Volleyball (B & G)
kshyo Kushwaha	0818231039	B-1(AIML)	♣♣ Chess (B & G) Individual Events;♣♣ Volleyball (B & G)
er Jatin	0818I7231073	A-4(IT)	♣♣ Cricket (only Boys);♣♣ Table Tennis (B & G) Individual Events
suraj Patilwat	0818I7231006	A-4(IT)	♣♣ Cricket (only Boys);♣♣ Table Tennis (B & G) Individual Events

For IIST/ IIP/ IIMR

Chief Administrative Officer

IQAC





Principal
Principal
Indore Institute of Science
and Technology, Indore
Saturday, December 21, 2024



njeet yadav	0818CSE231152	A-2(CS)	30c Cricket (only Boys)
SHRAJ CHHENIYA	0818IS231039	B-4(IOT)	30c Chess (B & G) Individual Events;30c Volleyball (B & G)
sh yadav	0818ME231023	B-4(ME)	30c Cricket (only Boys)
narva Barve	0818CL231014	B-1(AIML)	30c Cricket (only Boys)
hikant Namdev	0818CS231155	A-2(CS)	30c Table Tennis (B & G) Individual Events
HISHEK jayant	0818EC231002	B-3(EC)	30c Chess (B & G) Individual Events
tik songara	0818ME231010	B-4(ME)	30c Chess (B & G) Individual Events
it chaurasiya	0818CS231191	A-3(CS)	30c Pickleball (B & G) Individual Event;30c Table Tennis (B & G) Individual Events;30c Volley
el Bawne	0818IS231002	B-4(IOT)	30c Cricket (only Boys);30c Chess (B & G) Individual Events
nice Chopra	0818CD231053	B-2(DS)	30c Cricket (only Boys);30c Chess (B & G) Individual Events
tya Gawande	0818cs231012	A-1(CS)	30c Cricket (only Boys);30c Chess (B & G) Individual Events;30c Table Tennis (B & G) Individ
ka Agrawal	0818CS231089	A-2(CS)	Basketball;30c Chess (B & G) Individual Events
ashika nagde	0818CS231215	A-3(CS)	Basketball;30c Pickleball (B & G) Individual Event;30c Volleyball (B & G)
na gupta	0818cs231065	A-1(CS)	Basketball;30c Pickleball (B & G) Individual Event;30c Volleyball (B & G)
l Kumar Singh	0818CD231009	B-2(DS)	Basketball;30c Cricket (only Boys);30c Table Tennis (B & G) Individual Events
hil tikhtkar	0818cs231126	A-2(CS)	30c Table Tennis (B & G) Individual Events
hav Verma	0818IS231019	B-4(IOT)	30c Chess (B & G) Individual Events;30c Volleyball (B & G)
rayya Sharma	0818CS231094	A-2(CS)	30c Chess (B & G) Individual Events
sumn Patidar	0818CS231136	A-2(CS)	30c Cricket (only Boys)
esh deshmkh	0818CE231003	B-4(CE)	30c Chess (B & G) Individual Events;30c Volleyball (B & G)
resh Tawari	0818ME231016	B-4(ME)	30c Cricket (only Boys);30c Chess (B & G) Individual Events
an singh malviya	0818EC231027	B-3(EC)	30c Volleyball (B & G)
rav choudhary	0818EC231014	B-3(EC)	30c Cricket (only Boys);30c Volleyball (B & G)
absh patidar	0818EC231050	B-3(EC)	30c Cricket (only Boys)
absh patidar	0818EC231050	B-3(EC)	30c Cricket (only Boys)
vin Chouhan	0818IS231005	B-4(IOT)	30c Pickleball (B & G) Individual Event;30c Volleyball (B & G)
njan Singh Panwar	0818CD231044	B-2(DS)	30c Chess (B & G) Individual Events;30c Volleyball (B & G)
aj vishwakarma	0818IS231036	B-4(IOT)	30c Pickleball (B & G) Individual Event;30c Volleyball (B & G)
it Tawar	0818IS231034	B-4(IOT)	30c Pickleball (B & G) Individual Event;30c Volleyball (B & G)
endra kote	0818IT231038	A-4(IT)	30c Cricket (only Boys)
ishth Bairagi	0818IT231020	A-4(IT)	30c Cricket (only Boys);30c Table Tennis (B & G) Individual Events

For IIST/ IIP/ IIMR

Chief Administrative Officer

IQAC





Principal
Principal
Indore Institute of Science
and Technology, Indore
Saturday, December 21, 2024



Rishu Kumar Singh	0818CS231156	A-2(CS)	â€¢ Cricket (only Boys)
Deepanshu Gupta	0818CL231020	B-1(AIML)	â€¢ Chess (B & G) Individual Events;â€¢ Volleyball (B & G)
Sahil matviya	0818CD231060	B-2(DS)	â€¢ Cricket (only Boys)
vansh vaishnav	0818CS231214	A-3(CS)	â€¢ Cricket (only Boys)
Nitish kumar	0818CS231128	A-2(CS)	â€¢ Chess (B & G) Individual Events
ayesh Jangle	0818IS231018	B-4(IOT)	â€¢ Cricket (only Boys);â€¢ Volleyball (B & G)
tugal patil	0818CS231232	A-3(CS)	â€¢ Cricket (only Boys)
Jakul Pandya	0818EC231035	B-3(EC)	â€¢ Cricket (only Boys)
ryan Mishra	0818CD231006	B-2(DS)	â€¢ Cricket (only Boys)
run patil	0818CS231045	A-1(CS)	â€¢ Cricket (only Boys)
aishav verma	0818CS231091	A-2(CS)	â€¢ Cricket (only Boys);â€¢ Pickleball (B & G) Individual Event
aishav verma	0818CS231091	A-2(CS)	â€¢ Cricket (only Boys);â€¢ Pickleball (B & G) Individual Event
diya Singh bhadoriya	0818EC231003	B-3(EC)	â€¢ Cricket (only Boys)
omyak jain	0818CS231167	A-3(CS)	â€¢ Cricket (only Boys);â€¢ Pickleball (B & G) Individual Event
eeraj yadav	0818CS231121	A-2(CS)	â€¢ Cricket (only Boys)
diya Thatte	0818IT231004	A-4(IT)	â€¢ Cricket (only Boys);â€¢ Chess (B & G) Individual Events;â€¢ Volleyball (B & G)
Prakash bagdawat		36 A-4(IT)	Basketball;â€¢ Cricket (only Boys);â€¢ Pickleball (B & G) Individual Event
aduraj Chheniya	0818CD231072	B-2(DS)	â€¢ Cricket (only Boys);â€¢ Pickleball (B & G) Individual Event
nince Chouhan	0818IT231055	A-4(IT)	â€¢ Cricket (only Boys)
AYUR KOSE	0818CS231114	A-2(CS)	â€¢ Cricket (only Boys)
zwan khan	0818IT231058	A-4(IT)	â€¢ Pickleball (B & G) Individual Event;â€¢ Volleyball (B & G)
adhusudan singh gaud		35 B-2(DS)	Basketball;â€¢ Cricket (only Boys);â€¢ Pickleball (B & G) Individual Event;â€¢ Table Tennis (
han Pamnani	0818CS231088	A-2(CS)	â€¢ Chess (B & G) Individual Events;â€¢ Pickleball (B & G) Individual Event
han Pamnani	0818CS231088	A-2(CS)	â€¢ Chess (B & G) Individual Events;â€¢ Pickleball (B & G) Individual Event
UJESH VISHWAKARMA	0818IT231017	A-4(IT)	â€¢ Cricket (only Boys)
ddrishi Bairagi	0818IT231020	A-4(IT)	â€¢ Cricket (only Boys)
etan tirole	0818EC231011	B-3(EC)	â€¢ Cricket (only Boys);â€¢ Volleyball (B & G)
dy Dangl	0818CS231016	A-1(CS)	â€¢ Cricket (only Boys);â€¢ Pickleball (B & G) Individual Event;â€¢ Volleyball (B & G)
idharth sonone	0818CD231064	B-2(DS)	Basketball;â€¢ Volleyball (B & G)
idharth sonone	0818CD231064	B-2(DS)	Basketball;â€¢ Volleyball (B & G)
ush kale	0818CD231010	B-2(DS)	â€¢ Cricket (only Boys)

For IIST/ IIP/ IIMR
 Chief Administrative Officer

 IQAC



 Principal
 Indore Institute of Science
 and Technology, Indore
 Saturday, December 21, 2024



10. Report on National Sports Day Celebration Dated- 29 Aug 2023

Indore Institute of Science & Technology, Indore

Department of Sports

Date: - 29th August-2023

Report on National Sports Day Celebration

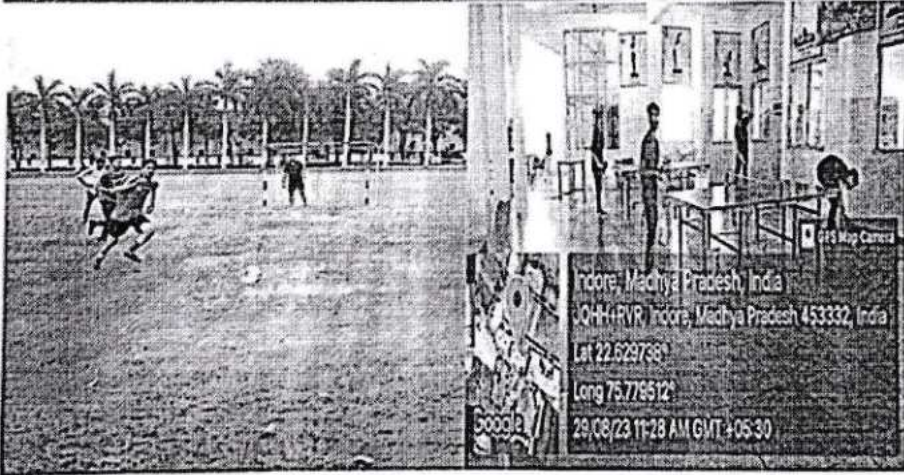
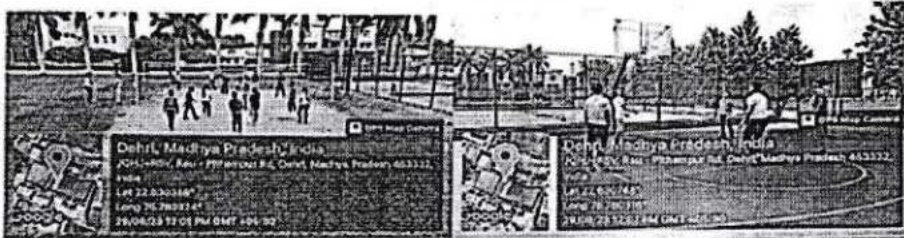

For IIS/ IIP/ IIMR

Chief Administrative Officer





Principal
Principal
Indore Institute of Science
& Technology, Indore
Saturday, December 21, 2024



W. National Sports Day Celebration Approval Letter Dated- 16 Aug 2023

Indore Institute of Science & Technology, Indore

Approval Letter

To,

Date: -16/08/2023

Dr Keshav Patidar
Principal
IIST Collage, Indore

Subject: - Permission to organize National Sports Day-2023.

Respected Sir,

Indore Institute of Science & Technology (IIST) is organizing National Sports Day on 29th August-2023. Sir, I request you to please permit to organize National Sports Day-2023.

Thanking You

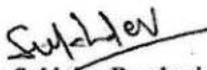

Dr. Sukhdev Bamboriya
Dean, Physical Education & Sports
Physical Education & Sp.
Indore Institute of Science
& Technology, INDORE



Dr Keshav Patidar
Principal, IIST, Indore
Indore Institute of Science
and Technology, Indore

For IIST/ IIP/ IIMR
Chief Administrative Officer



Principal
Indore Institute of Science
Technology, Indore
Saturday, December 21, 2024



Indore Institute of Science & Technology (IIST) Indore is successfully conducted **National Sports Day on 29th August 2023** on the occasion of **Major Dhyan Chan Birthday** celebration.

Department of Sports has organized **Friendly Matches of Indoor & Outdoor** between Faculty and Students of different games. Institute faculty has participated in **National Sports Day friendly matches** and enjoy the Sports Day.

Dr. Sukhdev Hamboriya
Dean, Sports
Physical Education
Indore Institute of Science
& Technology, INDORE

Dr Keshav Patidar
Principal IIST
Principal
Indore Institute of Science
and Technology, Indore



For IIST/ IIP/ IIMR

Chief Administrative Officer



Principal
Principal
Indore Institute of Science
and Technology, Indore
Saturday, December 21, 2024



X. Sports Notice Dated- 17 Sep 2023

Indore Institute of Science & Technology, Indore

Department of Sports

Sports Notice

Date: -17/09/2023

Indore Institute of Science and Technology are organizing Friendly Matches of Volleyball, Basketball, Table Tennis & Pickleball (Indoor & Outdoor) on the occasion of National Sports Day on 29th August. Those students (Boys & Girls) & Faculties who are interested to participate in this event, kindly submit their name at sports department. By 21st August-2023.

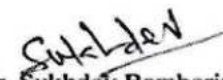
Dr. Sukhdev Bamboriya
Dean, Sports
Physical Education
Indore Institute of Science
& Technology, INDORE

Dr. Keshav Patidar
Principal, IIST
Principal
Indore Institute of Science
and Technology, Indore



IQAC

Principal
Principal
Indore Institute of Science
and Technology, Indore
Saturday, December 21, 2024

For IIST/ IIP/ IIMR

Chief Administrative Officer





Y. National Sports Day Celebration Attendance Sheet Record

INDORE INSTITUTE OF SCIENCE & TECHNOLOGY
NAME OF ACTIVITY: NATIONAL SPORTS DAY ON 21st August, 2023

S.No	Name	Branch	Signature
1	AAYUSHI PRAJAPAT	IOT	Aayushi
2	ANKIT BAWNE	IOT	Ankit
3	ANURAG PRATAP SINGH	IOT	Anurag
4	APEKSHA SILARPURIA	IOT	Apeksha
5	ASHVIN CHOUHAN	IOT	Ashvin
6	AYUSH RAGHUWANSHI	IOT	Ayush
7	BHAVESH NARIYA	IOT	Bhavesh
8	CHINMAY AGRAWAL	IOT	Chinmay
9	DEEPAK SHAH	IOT	Deepak
10	DEVYANSH KARMA	IOT	Devyansh
11	GUNJAN SISODIYA	IOT	Gunjan
12	HARSH NARIYA	IOT	Harsh
13	HARSHAL BHAGWATKAR	IOT	Harshal
14	HARSHITA BHAYAL	IOT	Harshita
15	ISHITA JAIN	IOT	Ishita
16	ISHITA MUKKERKAR	IOT	Ishita
17	JAYESH GURJAR	IOT	Jayesh
18	JAYESH JANGLE	IOT	Jayesh
19	KESHAV DINESH VERMA	IOT	K. D. Verma
20	MAHI RAGHUVANSHI	IOT	Mahi
21	MAYANK YADAV	IOT	Mayank
22	MEET MOGRA	IOT	Meet
23	MOHAMMAD UWAISH	IOT	Moh.
24	NIPURN SONI	IOT	Nipurn
25	NIRAJ	IOT	Niraj
26	PALAK DRONAWAT	IOT	Palak
27	PARAG ADLOK	IOT	Parag
28	PREETI TANWAR	IOT	Preeti
29	RATNESH KUMAR DWIVEDI	IOT	Ratnesh
30	SANSKAR VERMA	IOT	Sanskar
31	SHIVAM PRAJAPATI	IOT	Shivam
32	SHIWANSH PANDEY	IOT	Shiwansh
33	SIDDHARTH SEN	IOT	Siddharth
34	SUMIT	IOT	Sumit
35	TANISHQ VYAS	IOT	Tanishq
36	TANUJ VISHWAKARMA	IOT	Tanuj
37	VANSHIKA CHOURASIA	IOT	Vanshika
38	YASHIKA RANA	IOT	Yashika
39	YASHRAJ CHHENIYA	IOT	Yashraj
40	AJAY VERMA	IOT	Ajay

Sudhakar
Dean
Physical Education & Sports
Indore Institute of Science
& Technology, INDORE

dr
IQAC

U

Principal
Principal

Indore Institute of Science
& Technology, Indore
Saturday, December 21, 2024

Page
For IIST/ IIMR
Chief Administrative Officer







Z. Glimpse of National Sports Day Celebration

Indore Institute of Science & Technology, Indore
Department of Sports

A brief report on 10th International Yoga Day on 21st June-2024

As per the direction of the Ministry of AYUSH, AICTE & UGC Government of India, the Indore Institute of Science & Technology, (IIST) Indore (M.P.) celebrated the 10th International Yoga Day (Theme- Yoga for Self & Society) in campus on 21st June 2024. Dr. Keshav Mishra (Principal IIST) Welcomed Yoga Instructor Ms. Kaya Shamnani & Mr. Anand Mishra (Qualified from Bihar School of Yoga). A mass Yoga Demonstration was organized in the morning on 21st June 2024 following the Common Yoga Protocol evolved and circulated by Ministry of AYUSH, Government of India. Ms. Kaya Shamnani & Anand Mishra Yoga instructor for Demonstrated various Yoga Poses to Professors, lecturers, staff, deans, workers and students in the Mass Yoga Session.



Anand Mishra
 Dean
 Physical Education & Sports
 Indore Institute of Science
 & Technology, INDORE

 For IIST/ IIP/ IIMR
 Chief Administrative Officer

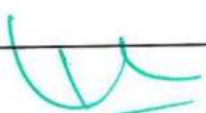

 Principal
 Indore Institute of Science
 and Technology, Indore
 Saturday, December 21, 2024



Dr. Keshav Patidar Presented Memento to Ms. Kaya Shamnani & Mr. Amit Shamnani after the closing of Program.

The whole program was well organized and the sessions were conducted in a well-disciplined manner. A few photographs of the event are attached.

Sukhdev
Dr. Sukhdev Banskari
Dean, Physical Education & Sports
Indore Institute of Science
& Technology, INDORE

[Signature]
Dr. Keshav Patidar
Principal, IIST
Principal
Indore Institute of Science
and Technology, Indore

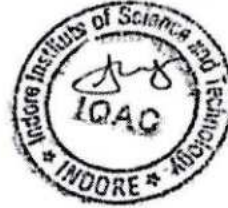

[Signature]
IQAC

[Signature]
For IIST/ IIP/ IIMR

Chief Administrative Officer



[Signature]
Principal
Indore Institute of Science
& Technology, Indore
Saturday, December 21, 2024



11. Intra Hostel Premier League 6th to 12th June 2024 Event Report Dated- 12 June 2024

IIST Group of Educational Institutes, Indore

VARAHAMHAR (Boys Hostel) /MAITREY (Girls Hostel)

Hostel Premier League 6th to 12th June-2024

Report on Intra Hostel (Inter Year) Sports Event

Date: -12th June-2024

Department of Sports has successfully organized Intra Hostel (Inter Year) Sports Event from 6th to 12th June-2024 in association with Hostel Department. The event was organized in league cum knock out basis. All the hostellers were participated in this event.

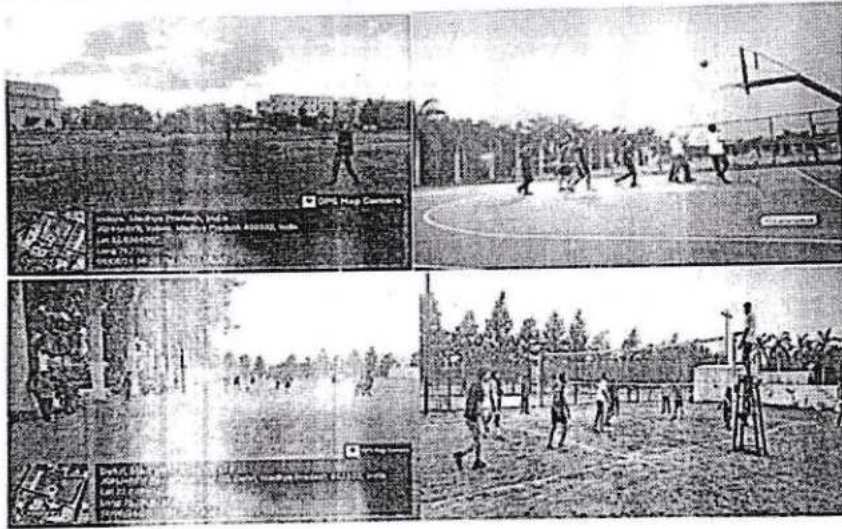

Sukhdev
Dean
Department of Sports
& Education & Sports
Indore Institute of Science
& Technology, INDORP



[Signature]
IQAC

[Signature]

Principal

Principal
Indore Institute of Science
& Technology, Indore
Saturday, December 21, 2024

For IIST *[Signature]*
IMR

Chief Administrative Officer





AA. Intra Hostel Premier League Sports Notice Dated- 2nd June 2024

IIST Group of Educational Institutes, Indore

VARAHAMIHIR (Boys Hostel) /MAITREY (Girls Hostel)

Hostel Premier League 6th to 12th June-2024

Sports Notice

Date: - 2nd June-2024

Department of Sports/Hostel is organizing Intra Hostel (Inter Year) Sports Event from 6th to 12th June-2024 under the banner of IIST Group of Educational Institutes, Indore.

The games are:-

- Basketball (B & G)
- Cricket (only for Boys)
- Mini Soccer (only for Boys)
- Volleyball (B & G)

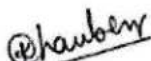

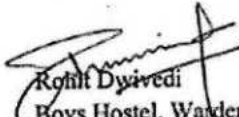
Kirti Choubey
Girls Hostel, Warden

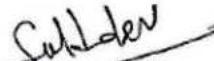
Rohit Dwivedi
Boys Hostel, Warden

Dr. Sukhdev Bamboriya
Dean Sports
Physical Education & Sports
Indore Institute of Science
& Technology, INDORE

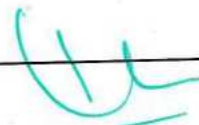

IQAC



Principal

Principal

Indore Institute of Science
& Technology, Indore
Saturday, December 21, 2024

For IIST/ IIP/ IIMR

Chief Administrative Officer





BB. Intra Hostel Premier League Approval Letter Dated- 1st June 2024

IIST Group of Educational Institutes, Indore

Department of Sports/Hostel

Approval Letter

Date: - 1st June-2024

Subject: - Permission to organize Intra Hostel (Inter Year) Sports Event.

Respected Sir,

Department of Sports/Hostel is organizing Intra Hostel (Inter Year) Sports Event from 6th to 12th June-24 under the banner of IIST Group of Educational Institutes, Indore. Basketball, Cricket, Mini Soccer (only Boys,) and Volleyball. Sir, we request you to kindly permit to organize above Events.

Ms. Kirti Choubey
Girls Hostel, Warden

M.K. Rohit Dwivedi
Boys Hostel, Warden

Dr. Sukhdev Bamboriya
Dean, Sports
Physical Education & Sports
Indore Institute of Science
& Technology, INDORE

Dr. Keshav Patidar
Principal, IIST
Indore Institute of Science
and Technology, Indore

Copy for information please:-
Chief Admin officer-1
Incharge-1st Year (Boys & Girls)
Incharge-2nd Year (Boys & Girls)
Incharge-3rd Year (Boys & Girls)
Incharge-4th Year (Boys & Girls)



Principal

Principal
Indore Institute of Science
and Technology, Indore
Saturday, December 21, 2024

For  IIMR
Chief Administrative Officer





IIST
Indore Institute of
Science & Technology

**Indore Institute of
Science & Technology**

Approved by AICTE, New Delhi, Affiliated to RGPV, Bhopal, Recognized by UGC under Section 2(f)
2023-2024

Pastor - HPL

HOSTEL PREMIER LEAGUE 2K24



Subles
Dean
Physical Education & Sports
Indore Institute of Science & Technology
INDORE

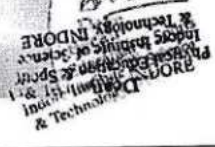

Subles
Indore Institute of Science & Technology
INDORE

[Signature]
For IIST/ IIP/ IIMR
Chief Administrative Officer



[Signature]
IOAC

[Signature]
Principal
Principal
Indore Institute of Science
& Technology, Indore
Saturday, December 21, 2024



Indore Institute of Science & Technology

Approved by AICTE, New Delhi, Affiliated to RGPV, Bhopal, Recognized by UGC under Section 2(f)
2023-2024

CC. Intra Hostel Premier League Attendance Sheet Record- 1st Year Students

1st year students

1) Palak soni	<i>Palak</i>
2) Vibha marskole	<i>Marskole</i>
3) Mahima patidar	<i>Patidar</i>
4) Amisha namdev	<i>Namdev</i>
5) Tanisha yadav	<i>Yadav</i>
6) Akriti ojha	<i>Akriti</i>
7) Mansi modi	<i>Mansi</i>
8) Gyanshi Singh	<i>Gyanshi</i>
9) Sachi dwivedi	<i>Sachi</i>
10) Akanksha Jain	<i>Akanksha</i>
11) Harshal raheja	<i>Harshal</i>
12) Paridhi laad	<i>Paridhi</i>
13) Riddhima tandon	<i>Riddhima</i>
14) Mahi gangrade	<i>Mahi</i>
15) Khushi rathore	<i>Khushi</i>
16) Khushi Rajawat	<i>Khushi</i>
17) Ishika Yadav	<i>Ishika</i>
18) Stuti Jain	<i>Stuti</i>
19) Shubhali gehlot	<i>Shubhali</i>
20) Ragini pawar	<i>Ragini</i>
21) Karnika singh	<i>Karnika</i>
22) Tanishka mishra	<i>Tanishka</i>
23) Simran tirole	<i>Simran</i>
24) Priyanshi sahu	<i>Priyanshi</i>
25) Anshita Goswami	<i>Anshita</i>
26) Vanshika Yadav	<i>Vanshika</i>
27) Payal pal	<i>Payal</i>
28) Priya sanjana	<i>Priya</i>
29) Prachi korde	<i>Prachi</i>
30) Prachi Patidar	<i>Prachi</i>
31) Diksha patidar	<i>Diksha</i>
32) Aditi rathore	<i>Aditi</i>
33) Chetna barmase	<i>Chetna</i>
34) Adeeba sheikh	<i>Adeeba</i>
35) Ishika Jain	<i>Ishika</i>

Total = 35 Girls Students

Sudhakar
Dean
Physical Education & Sports
Indore Institute of Science
& Technology, INDORE



[Signature]
Chief Administrative Officer

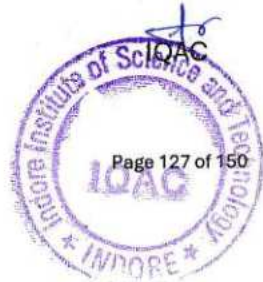

[Signature]
Principal
Indore Institute of Science
and Technology, Indore
Saturday, December 21, 2024



DD. Intra Hostel Premier League Attendance Sheet Record- 2nd Year Students

2nd year students

1. Shreya
2. Jaya
3. Anshika
4. Aashi
5. Vanshika
6. Neha
7. Poorvi
8. Priyanshi
9. Aarya
10. Shagun
11. Shveta

Total = 11 Students

Dean
Physical Education & Sports
Indore Institute of Science
& Technology, INDORE

For IIST IIP/ IIMR
Chief Administrative Officer



Principal
Indore Institute of Science
and Technology, Indore

Saturday, December 21, 2024



EE.Intra Hostel Premier League Attendance Sheet Record- 3rd Year Students

3rd year Students

- 1. Kajal *Kajal*
- 2. Diti *Diti*
- 3. Anamika *Anamika*
- 4. Priya Kuldeep *Priya*
- 5. Priyanka Nimbulkar *Priyanka*
- 6. Payal Samanta *Payal*
- 7. Tanishka Bansal *Tanishka*

Total = 07 Students

Sudha
Dean
Physical Education & Sports
Indore Institute of Science
& Technology, INDORE



[Signature]
For IIST/ IIP/ IIMR

Chief Administrative Officer



[Signature]

Principal
Principal
Indore Institute of Science
& Technology, Indore
Saturday, December 21, 2024



IIST
Indore Institute of
Science & Technology

Indore Institute of Science & Technology

Approved by AICTE, New Delhi, Affiliated to RGPV, Bhopal, Recognized by UGC under Section 2(f)
2023-2024

FF. Intra Hostel Premier League Attendance Sheet Record- 4th Year MBA, M. Pharma
Students

4th year, MBA, M. Pharma

MBA

1. Humera *Humera*
2. Riya Patidar *Riya*
3. Chitrakshi *Chitrakshi*

M. Pharma

1. Jyoti Singh *Jyoti*

B. Tech.

1. Chandani *Chandani*
2. Nirmala *Nirmala*
3. Dhapu *Dhapu*
4. Anjana *Anjana*

Total :- 08 Students

Subbed
Dean

Physical Education & Sports
Indore Institute of Science
& Technology, INDORE



Dr
IQAC

Principal
Principal

Indore Institute of Science
& Technology, Indore

Saturday, December 21, 2024

Angee
For IIST/ IIP/ IIMR
Chief Administrative Officer





GG. Intra Hostel Premier League Attendance Sheet Record – Hostel 1st Year Students

Hostel 1st year		
1	Kartavya Agrawal	006 7987467150
2	Harshit Choudhry	006 6299706536
3	Nilesh Kumar Jha	006 8825270975
4	Abhishek Mathuria	005 9109076795
5	Piyush Dubey	005 9305297238
6	Vincent	004 8085762086
7	Shivam Diwakar	004 9608266454
8	Jay Diwedi	004 920226731
9	Nivek Kumar	003 8707499365
10	Nivek Dubey	003 9977158551
11	Samaath Chawla	003 6265419023
12	Diyansh Gupta	107 6387240416
13	Uday Kiran	008 9030792593
14	Prabhakar Pandey	008 9942595709
15	Madhusudhan Ch.	008 7000697764
16	Bupendra Kushwah	007 8319345815
17	Vikas Rajput	009 6263464337
18	Pmit Bhadouria	009 6261868675
19	Anurag Sharma	010 7440882779
20	Aditya	011 9630195804
21	Priyansh Duggad	011 7223921133
22	Keshav Mahajan	011 6260567463
23	Shekhar Gupta	011 7067901167
24	Kundan Soni	012 9630802470
25	Aman Mansoori	012 9399075508

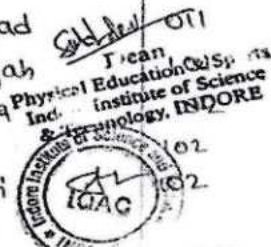

Page - 01

For IIST, IIP/ IIMR

Chief Administrative Officer



Principal

Principal
Indore Institute of Science
& Technology, Indore
Saturday, December 21, 2024



26	Aryan Wagle	103	9669800398
27	Devansh Jain	103	8643098388
28	Saunnil Sharma	103	9244271583
29	Sagar Dikshit	104	9131582915
30	Vait Nasoliya	104	9201302062
31	Mans Diwed	104	8817688268
32	Aaditya Jai	105	9907726223
33	Priyank	105	9978296854
34	Paav	105	9340482220
35	Anshumant Patel	106	9340927383
36	Naitik Seth	106	8815023864
37	Sahil Keshavnami	110	9529895744
38	Rajat kumar	110	9279223591
39	Jugal AB Thomas	111	8435166496
40	Arsh Solanki	111	7879277420
41	Shaligram Tiwari	109	9086587477
42	Yash karnuara	109	7898327084
43	Varbhav makwana	108	6376328975
44	Shreyas	110	7304013098
45	Karthik K. B.	112	7204830214
46	Siddh Sharma	111	7987946712
47	Hariday	103	

For IIST/ IIP/ IIMR

Chief Administrative Officer



Principal

Principal
Indore Institute of Science
and Technology, Indore
Saturday, December 21, 2024



HH. Intra Hostel Premier League Attendance Sheet Record- 1 Ralamandal 2nd Year Students

Ralamandal		First Year	Second
1)	Annav Sharma	✓	
2)	Arjun Singh Bhati	✓	
3)	Aditya Thalte	✓	
4)	Deepanshu Gupta	✓	
5)	Harsh Kala	✓	
6)	Gourav Kumar	✓	
7)	Keshav Teja	✓	
8)	Chaitanya Kumar	✓	
9)	Yashraj Chheniya	✓	
10)	Yashraj Chheniya	✓	
11)	Nigam Kumar	✓	
12)	Nishant Dawareli	✓	
13)	Nitin Mehra	✓	
14)	Harshit Singh	✓	
15)	Amitabh Panjori	✓	
16)	Smrit Chauhan	✓	
17)	Prabal Pratap Singh	✓	
18)	Jayesh Mathankar	✓	
19)	Prabhakar Tiwari	✓	
20)	Ajay Dangi	✓	
21)	Nikhil Raj	✓	
22)	Nitish Kumar	✓	
23)	Gautam Sharma	✓	
24)	Radhakrishna Gupta	✓	
25)	Shamil Mansuri	✓	
26)	Sachin Yadav	✓	
27)	Rishabh Patidar	✓	
28)	Harshwardhan	✓	
Total 27 Students		16	33



Dean
Sports Science
INDORE

28 Done

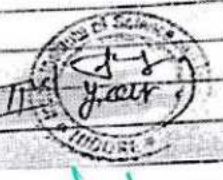

For IIST/ IIP/ IIMR

Chief Administrative Officer



Principal
Indore Institute of Science
and Technology, Indore
Saturday, December 21, 2024



II. Intra Hostel Premier League Attendance Sheet Record- Hostel 2nd Year Students

Ralamandal 1st Year Second		OMKALA
		Date: / / Page No:
1)	Arnav Sharma ✓	
2)	Arjun Singh Bhati ✓	
3)	Aditya Thakre ✓	
4)	Deepanshu Gupta ✓	
5)	Harsh Kala ✓	
6)	Gourav Kumar ✓	
7)	Keshav Teja ✓	
8)	Chaitanya Kumar ✓	
9)	Yashraj Chheniya ✓	
10)	Yashraj Chheniya ✓	
11)	Nigam Kumar ✓	
12)	Nishant Dweedi ✓	
13)	Nitin Mehra ✓	
14)	Harshit Singh ✓	
15)	Anitabh Ranjan ✓	
16)	Smit Chauhan ✓	
17)	Prabal Pratap Singh Mahar Chauhan ✓	
18)	Jayesh Mathankar ✓	
19)	Prabhakar Tiwari ✓	
20)	Ajay Dangi ✓	
21)	Nikhil Raj ✓	
22)	Nikish Kumar ✓	
23)	Gautam Sharma ✓	
24)	Radhika Krishna Gupta ✓	
25)	Shamil Mansuri ✓	
26)	Sachin Yadav ✓	
27)	Rishabh Patidar ✓	
28)	Harshwardhan ✓	
(Total 27 Students from 1st Year)		
-16 → (33)		

Subedar
Dean
Physical Education
Intra-Hostel
&
Sports Science
INDORE

28 Done



IQAC



For IIST/ IIP/ IIMn
Chief Administrative Officer

Principal
Indore Institute of Science and Technology, Indore
Saturday, December 21, 2024



			FACE
1-	Aswani Tiwari	005	9131846107
2-	Aditya	107	
3-	Ankur	107	
4-	Himanshu Chaturvedi	009	
5-	Raman Dubey	010	9039969195
6-	Digvijay Parmar	010	9664750104
7-	Divyanshu Sharma	101	7999327958
8-	Arush	106	
9-	Aditya	107	
10-	Ankur	107	
11-	Nikhil	108	
12-	Aditya	108	
13-	Neeraj Goyal	011	7805985491
	Mohit Rathore	112	9226086754
	Aakash Mashal	112	7891514228



S. K. Mishra
Dean
Education & Sports
Indore Institute of Science
& Technology, INDORE

[Signature]
For IIST/ IIP/ IIMR

Chief Administrative Officer



[Signature]

Principal
Indore Institute of Science
& Technology, Indore
Saturday, December 21, 2024



JJ. Event- Inter College Tournament Report Dated- 18 March 2024

Indore Institute of Science & Technology Department of Sports Session-2023-24

Sports Report of Inter College (In House) on 18th March-2024

Academic Year: **2023-2024**

Name of Event: **Inter College Tournament**

Date of Event: **18th March-2024**

Event Coordinators: **Dr Sukhdev Bamboriya**

Details of Participants:

S.	Name of Events	No. of Participants	Department
1	Inter College - 2024 (Intramural- Inter Branches Competitions)	150	All Institutes IIST-IIP-IIMR

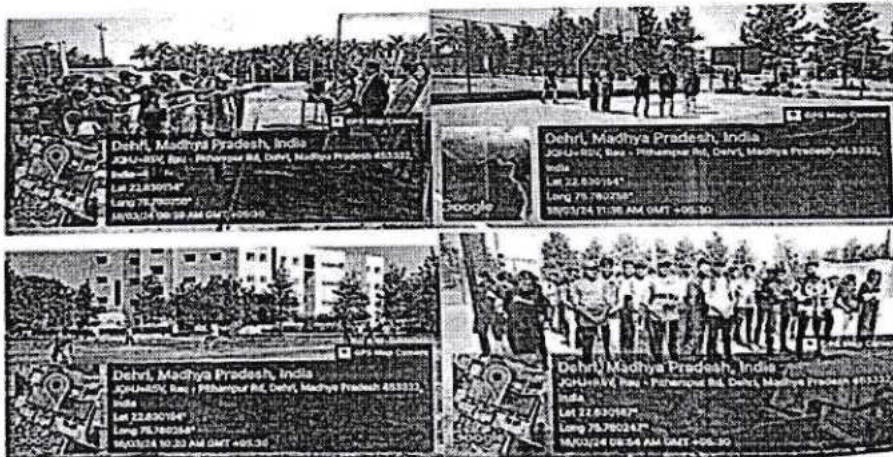

For IIST/ IIP/ IIMR

Chief Administrative Officer



Principal
Principal
Indore Institute of Science
and Technology, Indore
Saturday, December 21, 2024



Indore Institute of Science & Technology

Approved by AICTE, New Delhi, Affiliated to RGPV, Bhopal, Recognized by UGC under Section 2(f) 2023-2024

IIST-IIP-IIMR Group of Institutes Indore has successfully organized Inter College (In House) Sports Tournament on 18th March-2024. Total 6 Games (Basketball, Cricket, Chess, Pickleball, Table Tennis & Volleyball) for Boys & Girls were included in this meet. This is 1st time organized to introduces our players of different colleges.

All the matches were played Knock out Basis. The opening Ceremony Chief Guest was Hon'ble Group Advisor Sri Arun S Bhatnagar-IRS and Special Guest was Dr. Keshav Patidar Principal-IIST, Dr. Nimita Manocha Principal-IIP & Dr Aradhana Chouksey, Principal-IIMR.

All the Winners Team of different college/Branches are allowed to participate. The Result of the meet are attached here with Report.

IIST-IIP-IIMR Institute awarded Certificates to all the Winners & Runners Players with the presence of Hon'ble Group Advisor Sri Arun S Bhatnagar-IRS & Principal, IIST-IIP-IIMR. During the Closing Ceremony All Deans, HOD and Faculty of different department were present.

Sutabhai
Dr. Sukhdev Bamboriya
Dean, Sports
Physical Education & Sports
Indore Institute of Science
& Technology, INDORE

[Signature]
Dr Keshav Patidar
Principal, IIST
Principal
Indore Institute of Science
and Technology, Indore



[Signature]
IQAC

[Signature]
Principal
Indore Institute of Science
and Technology, Indore

[Signature]
For IIST/IIP/IIMR
Chief Administrative Officer



Saturday, December 21, 2024



KK. Items Requires for Annual Sports Meet Note Sheet Dated- 14 March 2024

**Indore Institute of Science & Technology, Indore
Department of Sports
Note Sheet**

Date: - 14th March-2024

Subject: - Items Require for Annual Sports Meet -2024.

Respected Sir,

IIST is organizing Annual Sports Meet on 16th & 17th March-2024 and organizing Inter College IIST/IIP/IIMR in our Premises. Following Item are required for smooth conduction of the event.

- Chairs 15 & Tables-5 nos
- Podium-1 & T- Table-1 nos
- Sound System on Cricket ground-1 nos
- Water Jar-3 nos
- Camera with Photo graphy-01 nos
- Bukey-02 nos
- Peon-2 Person
- Ambulance with Driver

Proposed Budget are: -

- Flex (8*6)-1 Rs. 500/-
- Officials Remuneration Rs: -7,000/-
- Certificate-190 nos Rs. 2000/-
- Medals-186 @ 40 nos Rs-8,000/-
- Overall championship Trophy-1 nos Rs. 500/-
- Tent 15*30 and 15*15 for 3 Days Rs: - 5,000/-

Total Amont: - 23,000/- Sir, kindly approve above amount for the Annual Sports.

Sukhdev
Dr. Sukhdev Bambariya
Dean
Physical Education & Sports
Indore Institute of Science
& Technology, INDORE

[Signature]
Dr. Keshav Patidar
Principal, IIST
Principal
Indore Institute of Science
and Technology, Indore



For IIST/ IIP/ IIMR
[Signature]
Chief Administrative Officer

[Signature]
IOAC



[Signature]
Principal
Principal
Indore Institute of Science
and Technology, Indore
Saturday, December 21, 2024

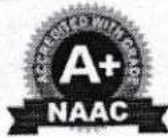

Indore Institute of Science & Technology

Approved by AICTE, New Delhi, Affiliated to RGPV, Bhopal, Recognized by UGC under Section 2(f) 2023-2024

12. Intra Hostel Premier League Report Dated- 12 June 2024

IIST Group of Educational Institutes, Indore

VARAHAMIHIR (Boys Hostel) /MAITREY (Girls Hostel)

Hostel Premier League 6th to 12th June-2024

Report on Intra Hostel (Inter Year) Sports Event

Date: -12nd June-2024

Department of Sports has successfully organized Intra Hostel (Inter Year) Sports Event from 6th to 12th June-2024 in association with Hostel Department. The event was organized in league cum knock out basis. All the hostellers were participated in this event.

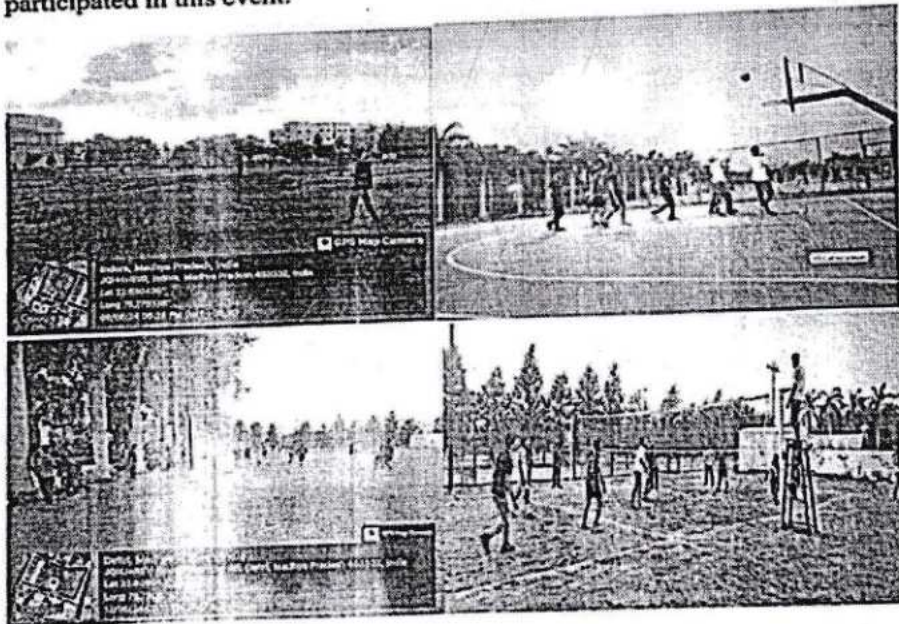

Sukhdev
Dean
Department of Sports
Education & Sports
Indore Institute of Science
& Technology, INDORE



[Signature]
For IIST IIP/ IIMR
Chief Administrative Officer

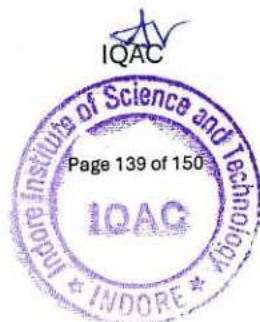

[Signature]
Principal
Principal
Indore Institute of Science
and Technology, Indore
Saturday, December 21, 2024



LL.Intra Hostel Premier League Sport Notice Dated- 2nd June 2024

IIST Group of Educational Institutes, Indore

VARAHAMIHIR (Boys Hostel) /MAITREY (Girls Hostel)

Hostel Premier League 6th to 12th June-204

Sports Notice

Date: - 2nd June-2024

Department of Sports/Hostel is organizing Intra Hostel (Inter Year) Sports Event from 6th to 12th June-2024 under the banner of IIST Group of Educational Institutes, Indore.

The games are:-

- Basketball (B & G)
- Cricket (only for Boys)
- Mini Soccer (only for Boys)
- Volleyball (B & G)

@haubey

Kirti Choubey
Girls Hostel, Warden

Rohit Dwivedi
Rohit Dwivedi
Boys Hostel, Warden

Sukhdev

Dr. Sukhdev Bamboriya
Dean Sports
Physical Education & Sports
Indore Institute of Science
& Technology, INDORE



[Signature]
FOR IIST/ IIP/ IIMR

Chief Administrative Officer

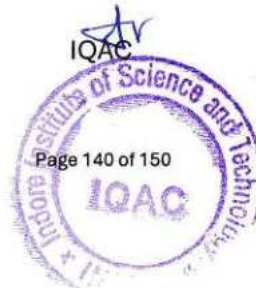

[Signature]
Principal
Principal
Indore Institute of Science
and Technology, Indore
Saturday, December 21, 2024



Indore Institute of Science & Technology

Approved by AICTE, New Delhi, Affiliated to RGPV, Bhopal, Recognized by UGC under Section 2(f) 2023-2024

MM. Intra Hostel Premier League Approval Letter Dated- 1st June 2024

IIST Group of Educational Institutes, Indore

Department of Sports/Hostel

Approval Letter

Date: - 1st June-2024

Subject: - Permission to organize Intra Hostel (Inter Year) Sports Event.

Respected Sir,

Department of Sports/Hostel is organizing Intra Hostel (Inter Year) Sports Event from 6th to 12th June-24 under the banner of IIST Group of Educational Institutes, Indore. Basketball, Cricket, Mini Soccer (only Boys,) and Volleyball. Sir, we request you to kindly permit to organize above Events.

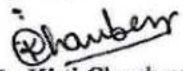
Ms. Kirti Choubey
Girls Hostel, Warden

Mr. Rohit Dwivedi
Boys Hostel, Warden

Dr. Sukhdev Bamboriya
Dean, Sports
Physical Education & Sports
Indore Institute of Science
& Technology, INDORE

Dr. Keshav Patidar
Principal, IIST
Indore Institute of Science
and Technology, Indore

Copy for information please: -
Chief Admin officer-1
Incharge-1st Year (Boys & Girls)
Incharge-2nd Year (Boys & Girls)
Incharge-3rd Year (Boys & Girls)
Incharge-4th Year (Boys & Girls)



For IIST IIP/ IIMR
Chief Administrative Officer



Principal
Indore Institute of Science
and Technology, Indore

Saturday, December 21, 2024



IIST
Indore Institute of
Science & Technology

**Indore Institute of
Science & Technology**

Approved by AICTE, New Delhi, Affiliated to RGPV, Bhopal, Recognized by UGC under Section 2(f)
2023-2024

NN. Hostel Premier League 2024

Paster

HOSTEL PREMIER LEAGUE 2K24



Sulbhas
Dean
Physical Education & Sports
Indore Institute of Science & Technology
INDORE

Sulbhas
Principal
Indore Institute of Science & Technology
INDORE

[Signature]
For IIST IIP/ IIMR
Chief Administrative Officer



[Signature]
Principal
Indore Institute of Science
and Technology, Indore
Saturday, December 21, 2024

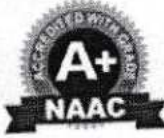

OO. Intra Hostel Premier League 1st Year Student Attendance

1st year students

- 1) Palak soni *Palak*
- 2) Vibha marskole *Vibha*
- 3) Mahima patidar *Mahima*
- 4) Amisha namdev *Amisha*
- 5) Tanisha yadav *Tanisha*
- 6) Akriti ojha *Akriti*
- 7) Mansi modi *Mansi*
- 8) Gyanshi Singh *Gyanshi*
- 9) Sachi dwivedi *Sachi*
- 10) Akanksha Jain *Akanksha*
- 11) Harshal raheja *Harshal*
- 12) Paridhi laad *Paridhi*
- 13) Riddhima tandon *Riddhima*
- 14) Mahi gangrade *Mahi*
- 15) Khushi rathore *Khushi*
- 16) Khushi Rajawat *Khushi*
- 17) Ishika Yadav *Ishika*
- 18) Stuti Jain *Stuti*
- 19) Shubhali gehlot *Shubhali*
- 20) Ragini pawar *Ragini*
- 21) Karnika singh *Karnika*
- 22) Tanishka mishra *Tanishka*
- 23) Simran tirole *Simran*
- 24) Priyanshi sahu *Priyanshi*
- 25) Anshita Goswami *Anshita*
- 26) Vanshika Yadav *Vanshika*
- 27) Payal pal *Payal*
- 28) Priya sanjana *Priya*
- 29) Prachi korde *Prachi*
- 30) Prachi Patidar *Prachi*
- 31) Diksha patidar *Diksha*
- 32) Aditi rathore *Aditi*
- 33) Chetna barmase *Chetna*
- 34) Adeeba sheikh *Adeeba*
- 35) Ishika Jain *Ishika*

Total = 35 Girls Students

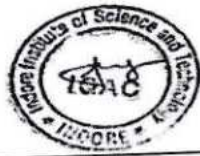

Sudhakar
Dean
Physical Education & Sports
Indore Institute of Science
& Technology, INDORE

[Signature]

For IIST IIP/ IIMR

Chief Administrative Officer



[Signature]
Principal
Indore Institute of Science
& Technology, Indore
Saturday, December 21, 2024

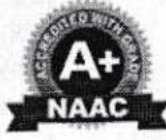

PP. Intra Hostel Premier League 2nd Year Student Attendance

2nd year students

1. Shreya
2. Jaya
3. Anshika
4. Aashi
5. Vanshika
6. Neha
7. Poorvi
8. Priyanshi
9. Aarya
10. Shagun
11. Shrivati

Total = 11 Students

Dean
Physical Education & Sports
Indore Institute of Science
& Technology, INDORE



For IIST/ IIP/ IIMR
Chief Administrative Officer



Principal
Indore Institute of Science
and Technology, Indore

Saturday, December 21, 2024



QQ. Intra Hostel Premier League 3rd Year Student Attendance

3rd year Students

1. Kajal *Kajal*
2. Diti *Diti*
3. Anamika *Anamika*
4. Priya Kuldeep *Priya*
5. Priyanka Nimbulkar *Priyanka*
6. Payal Samanta *Payal*
7. Tanishka Bansal *Tanishka*

Total = 07 Students

Sushil
Dean
Physical Education & Sports
Indore Institute of Science
& Technology, INDORE



[Signature]
For IIST/ IIP/ IIMR
Chief Administrative Officer



[Signature]
Principal
Principal
Indore Institute of Science
& Technology, Indore
Saturday, December 21, 2024



IIST
Indore Institute of
Science & Technology

Indore Institute of Science & Technology

Approved by AICTE, New Delhi, Affiliated to RGPV, Bhopal, Recognized by UGC under Section 2(f)
2023-2024

RR. Intra Hostel Premier League 4th Year Student MBA, M. Pharma Attendance

4th year, MBA, M. Pharma

MBA

1. Humera *Humera*
2. Riya Patidar *Riya*
3. Chitrakshi *Chitrakshi*

M. Pharma

1. Jyoti Singh *Jyoti*

B. Tech.

1. Chandani *Chandani*
2. Nirmala *Nirmala*
3. Dhapu *Dhapu*
4. Anjana *Anjana*

Total :- 08 Students

Sulabha
Dean

Physical Education & Sports
Indore Institute of Science
& Technology, INDORE



[Signature]

Principal

[Signature]
Chief Administrative Officer



Principal
Indore Institute of Science
& Technology, Indore
Saturday, December 21, 2024



SS. Hostel 1st Year Student Details

Hostel I st year		21101124
1	Kartavya Agrawal	006 7927467150
2	Harshit Choudhry	006 6299708536
3	Nilehil Kumar Jha	006 8825270975
4	Abhishek Madhusia	005 9109076795
5	Piyush Dubey	005 9305297238
6	Vincent	004 8085762086
7	Shivam Diwaker	004 9608266454
8	Jay Diwedi	004 920226731
9	Nivek Kumar	003 8707499365
10	Nivek Dubey	003 9977158551
11	Samaoth Chauha	003 6265419023
12	Diyansh Gupta	107 6387240416
13	Uday Kisan	008 9030792593
14	Prabhakar Pandey	008 8942595709
15	Madhusudhan Ch.	008 7000697764
16	Bupendra Kushwah	007 8319345815
17	Vikas Rajput	009 6263464337
18	Amit Bhadouria	009 6261868675
19	Anurag Sharma	010 7440882779
20	Aditya	011 9830195804
21	Priyansh Duggad	011 7223921133
22	Keshav Mahajan	6260567463
23	Shekhar Gupta	7067901167
24	Kundan Soni	9630802470
25	Aman Mansoori	9899075508

Indore Institute of Science & Technology
Ind. Institute of Science & Technology, INDORE
Physical Education Dept. IIST
Indore

Page - 01

For IIST/IIP/IIMR
Chief Administrative Officer



Principal
Indore Institute of Science
& Technology, Indore
Saturday, December 21, 2024



IIST
Indore Institute of
Science & Technology

Indore Institute of Science & Technology

Approved by AICTE, New Delhi, Affiliated to RGPV, Bhopal, Recognized by UGC under Section 2(f)
2023-2024

26	Aryan Wagle	103	9669800398
27	Devansh Jain	103	8643098388
28	Saunil Sharma	103	9244271583
29	Sagar Dikshit	104	9131582915
30	Udit Nasoliya	104	9201302062
31	Manas Dwivedi	104	8817688268
32	Aaditya Jai	105	9907726223
33	Priyank	105	9978296854
34	Parv	105	9340482220
35	Anshumant Patel	106	9340927383
36	Naitik Seth	106	8815023864
37	Sahil Keshavnani	110	9529895744
38	Rajat kumar	110	9279223591
39	Jubil AB Thomas	111	8435166496
40	Arsh Solanki	111	7879277420
41	Shaligam fivasi	109	9086587477
42	Yash kachwara	109	7898327084
43	Vaibhav makuana	108	6376328975
44	Shreyas	110	7304073098
45	Karthik k. B.	112	7204830214
46	Siddh Chandra	111	7987346717
47	Hariday	107	

For IIST/ IIP/ IIMR

Chief Administrative Officer

IQAC

Page 148 of 150



Principal

Indore Institute of Science
and Technology, Indore

Saturday, December 21, 2024



TT.Hostel 2nd Year Student Attendance

Ralamandal First Year Second		Date	Page No.
1)	Arnav Sharma ✓		
2)	Arjun Singh Bhati ✓		
3)	Aditya Thalte ✓		
4)	Deepanshu Gupta ✓		
5)	Havish Kala ✓		
6)	Gourav Kumar ✓		
7)	Keshav Tejra ✓		
8)	Chaitanya Kumar ✓		
9)	Yashraj Chheniya ✓		
10)	Yashraj Chheniya ✓		
11)	Nigam Kumar ✓		
12)	Nishant Droveeli ✓		
13)	Nitin Mehra ✓		
14)	Hoshit Singh ✓		
15)	Amitabh Ranjan ✓		
16)	Smit Chauhan ✓		
17)	Prabal Pratap Singh Malaviya ✓		
18)	Jayesh Malankar ✓		
19)	Prabhakar Tiwari ✓		
20)	Ajay Dangi ✓		
21)	Nikhil Raj ✓		
22)	Nitish Kumar ✓		
23)	Garvit Sharma ✓		
24)	Rudha Krishna Gupta ✓		
25)	Shamil Mansuri ✓		
26)	Sachin Yadav ✓		
27)	Rishabh Patidar ✓		
28)	Harshwardhan ✓		
(Total 27 Students)			
+6 = 33			

OMKALA
Page No.

Stalder
Dean
Physical Education
& Sports
INDORE

28 Done



[Signature]
Chief Administrative Officer



[Signature]
Principal
Indore Institute of Science
and Technology, Indore
Saturday, December 21, 2024



1-	Aswani tiwari	005	9131846107
2-	Aditya	107	
3-	Ankur	107	
4-	Himanshu Chakwedi	009	
5-	Raman dubey	010	9039969195
6-	Digvijay Parmar	010	9669750104
7-	Divyanshu Sharma	101	7999327958
8-	Ayush	106	
9-	Aditya	107	
10-	Ankur	107	
11-	Nikhil	108	
12-	Aditya	108	
13-	Neeraj Goyal	011	7805985491
	Mohit Rathore	112	9226086754
	Akash Mashal	112	7891514228



Su/11/19
Dean
Education & Sports
Indore Institute of Science
& Technology, INDORE



For IIST/ IIP/ IIT

Chief Administrative Officer



Principal

Principal
Indore Institute of Science
& Technology, Indore
Saturday, December 21, 2024